

ATTACCHI SPECIFICI PER - SPECIFIC FITTING KIT FOR
 KIT DE MONTAGE SPECIFIQUE POUR - SPEZIFISCHER MONTAGEKIT FÜR
 ANLAJE ESPECÍFICO PARA

KAWASAKI KLR 650 2008

ISTRUZIONI DI MONTAGGIO - MOUNTING INSTRUCTIONS
 INSTRUCTIONS DE MONTAGE - BAUANLEITUNG - INSTRUCCIONES DE MONTAJE

①



SUPPORTO
 SUPPORT
 SUPPORT
 HALTERUNG
 SOPORTE

Q.TY n.2(Dx-Sx)

②



VITE TBEI M6x16mm
 SCREW
 VIS
 SCHRAUBE
 TORNILLO

Q.TY n.4

③



VITE TEF M6x35mm
 SCREW
 VIS
 SCHRAUBE
 TORNILLO

Q.TY n.2

④



RONDELLA Ø6mm
 WASHER Ø6mm
 RONDELLE Ø6mm
 SCHEIBE Ø6mm
 ARANDELA Ø6mm

Q.TY n.4

⑤



MOUSSE
 RUBBER PADS
 MOUSSE
 SCHUTZGUMMI
 ESPUMA ADHESIVA

Q.TY n.8

⑥



NON INCLUSO
 NOT INCLUDED IN THE BOX
 PAS INCLUS DANS LA BOITE
 NICHT ENTHALTEN IN
 DER VERPACKUNG
 NO ESTÁ INCLUIDO EN
 EL PAQUETE

⑦

COMPONENTI ORIGINALI
 ORIGINAL PARTS
 PARTIES ORIGINALES
 ORIGINAL BAUTEILE
 COMPONENTES ORIGINALES

Q.TY n.-

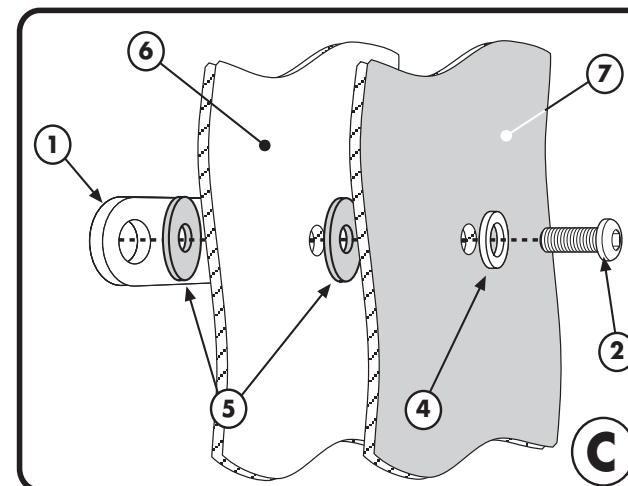
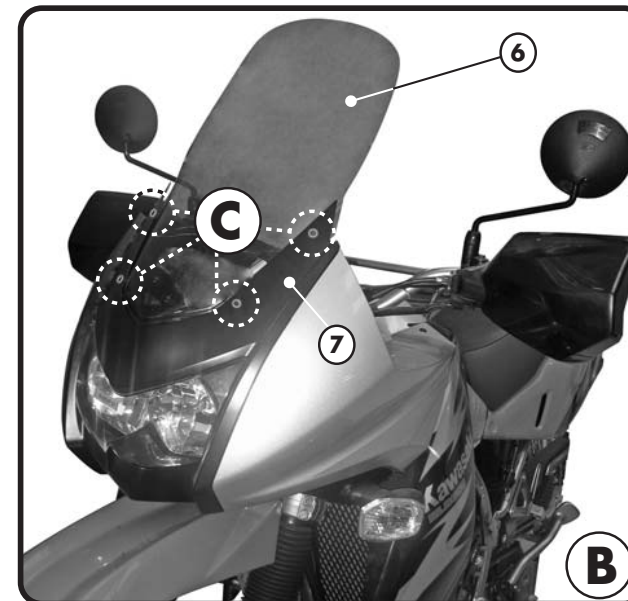
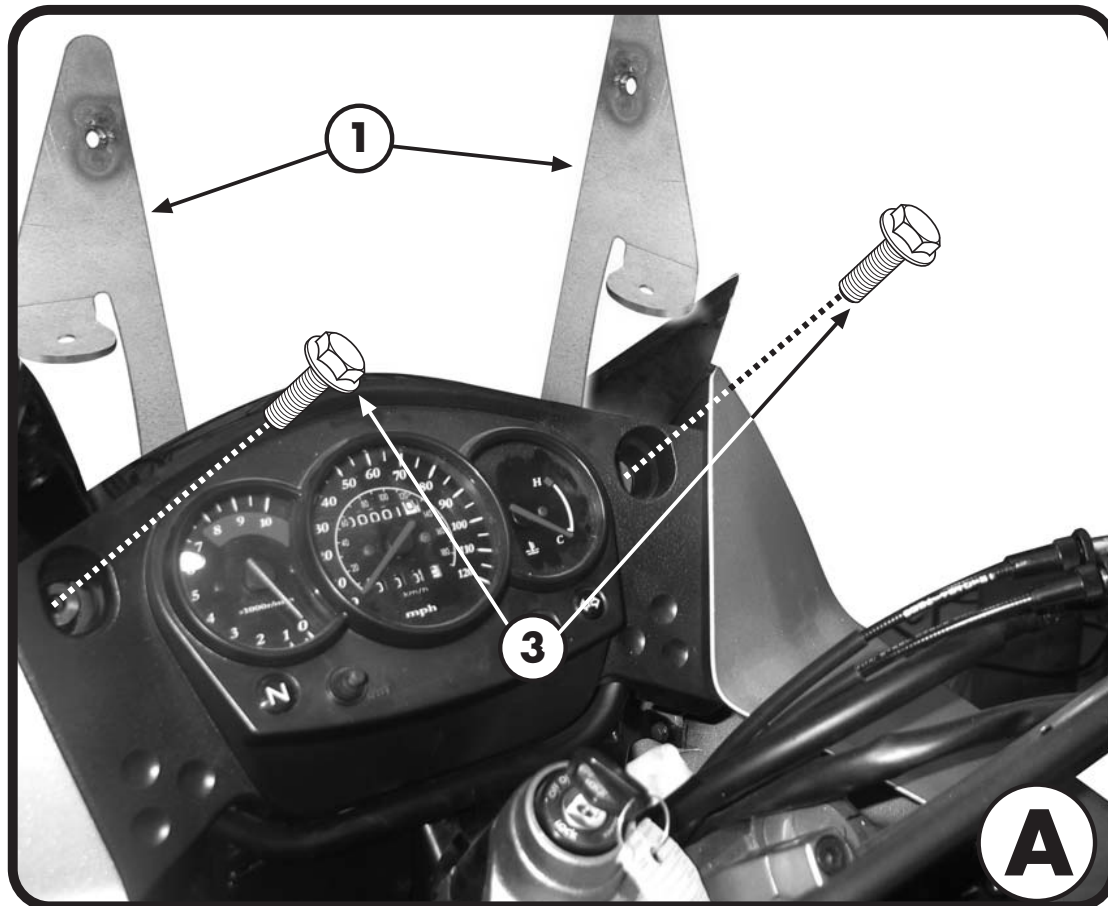

ATTACCHI SPECIFICI PER - SPECIFIC FITTING KIT FOR
KIT DE MONTAGE SPECIFIQUE POUR - SPEZIFISCHER MONTAGEKIT FÜR
ANLAJE ESPECÍFICO PARA

KAWASAKI KLR 650 2008

ISTRUZIONI DI MONTAGGIO - MOUNTING INSTRUCTIONS
INSTRUCTIONS DE MONTAGE - BAUANLEITUNG - INSTRUCCIONES DE MONTAJE

I ISTRUZIONI DI MONTAGGIO

1. DOPO AVER SMONTATO IL PARABREZZA ORIGINALE, INSERIRE E FISSARE I 2 SUPPORTI N°1 COME INDICATO IN FIGURA A;
2. POSIZIONARE IL PARABREZZA COME INDICATO IN FIGURA B;
3. PROCEDERE AL FISSAGGIO DEL PARABREZZA COME MOSTRATO IN FIGURA C.

GB MOUNTING INSTRUCTIONS

1. AFTER REMOVING THE ORIGINAL WIND-SCREEN, INSTALL THE TWO SUPPORTS, ITEM N°1, AS SHOWN IN PICTURE A;
2. SET THE WIND-SCREEN IN POSITION AS SHOWN IN PICTURE B;
3. FOLLOW THE INSTALLATION PROCEEDURE FOR THE WIND-SCREEN AS DIAGRAMMED IN PICTURE C.

F INSTRUCTIONS DE MONTAGE

1. APRES AVOIR DEMONTE LE PARE-BRISE D'ORIGINE, INSERER ET FIXER LES DEUX SUPPORTS N°1 COMME INDIQUE EN PHOTO A;
2. POSITIONNER LE PARE-BRISE COMME INDIQUE EN PHOTO B;
3. PROCEDER A LA FIXATION DU PARE-BRISE COMME ILLUSTRE EN PHOTO C.

D BAUANLEITUNG

1. DEMONTIEREN SIE DIE ORIGINALSCHEIBE UND BEFESTIGEN SIE DIE 2 HALTERUNGEN (POSITION NR. 1) WIE IM BILD A GEZEIGT;
2. POSITIONIEREN SIE DIE SCHEIBE WIE IM BILD B GEZEIGT;
3. BEFESTIGEN SIE DIE SCHEIBE WIE IM BILD C GEZEIGT.

ES INSTRUCCIONES DE MONTAJE

1. DESPUÉS DE HABER DESMONTADO EL PARABRISAS ORIGINAL , INSERTAR Y FIJAR LOS DOS SOPORTES N.1 COMO ESTÁ INDICADO EN LA FOTO "A";
2. COLOCAR EL PARABRISAS COMO SE INDICA EL LA FOTO "B";
3. PROCEDER FIJANDO EL PARABRISAS COMO FIGURA EN LA ILUSTRACIÓN " C".