

# UT810

BORSA DA SERBATOIO TANKLOCKED - TANKLOCKED BAG - SACOCHE DE RÉSERVOIR TANKLOCKED  
TANKRUCKSACK TANKLOCKED - BOLSA DE SOBREDEPOSITO TANKLOCKED - BOLSA DE TANQUE TANKLOCKED

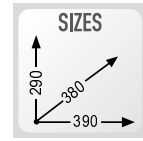

**VOLUME**  
**25lt**

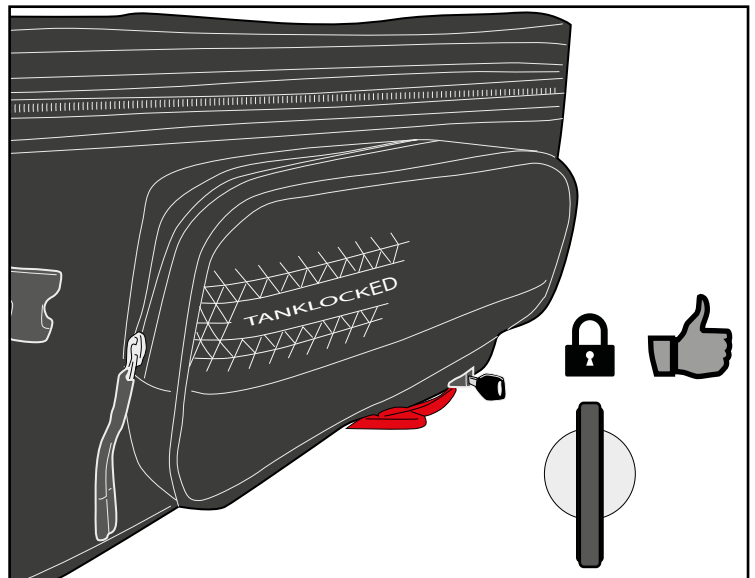
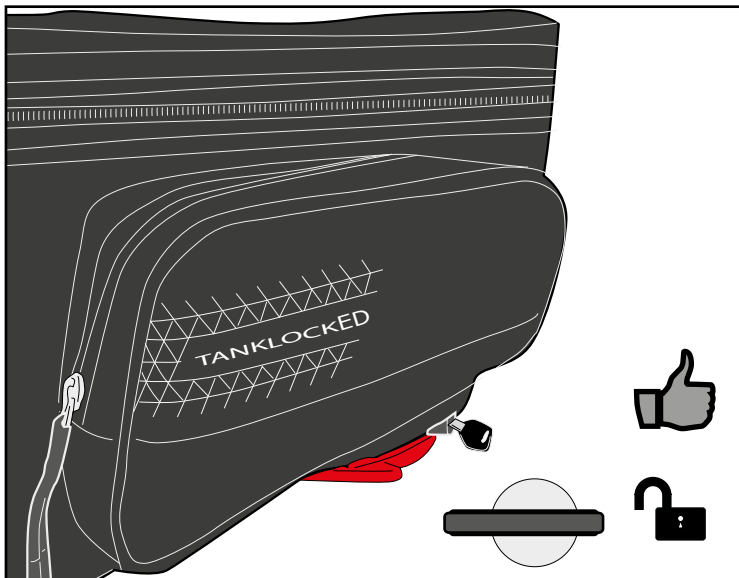
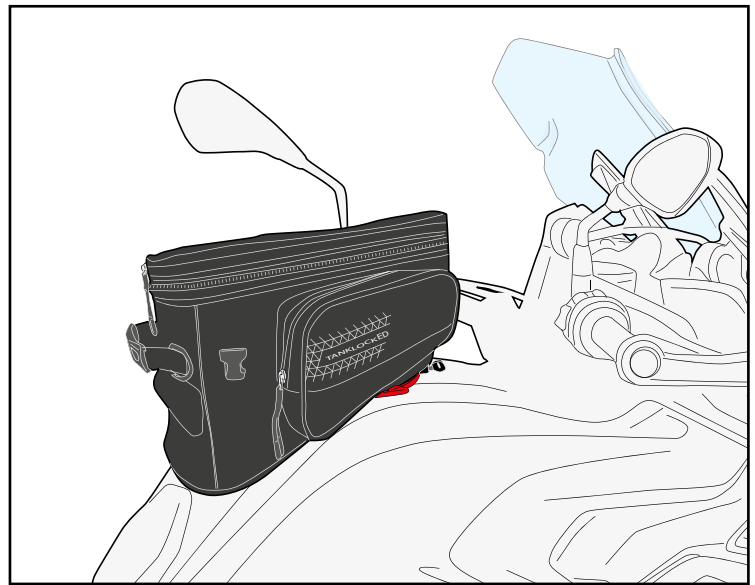
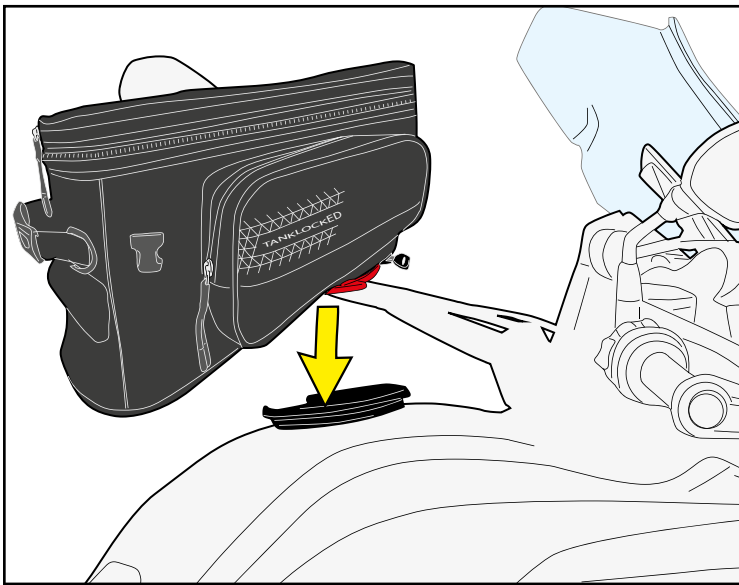
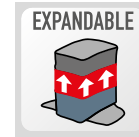

ISTRUZIONI DI MONTAGGIO - MOUNTING INSTRUCTIONS  
INSTRUCTIONS DE MONTAGE - BAUANLEITUNG  
INSTRUCCIONES DE MONTAJE - INSTRUÇÕES DE MONTAGEM

# UT810

BORSA DA SERBATOIO TANKLOCKED - TANKLOCKED BAG - SACOCHE DE RÉSERVOIR TANKLOCKED  
TANKRUCKSACK TANKLOCKED - BOLSA DE SOBREDEPOSITO TANKLOCKED - BOLSA DE TANQUE TANKLOCKED

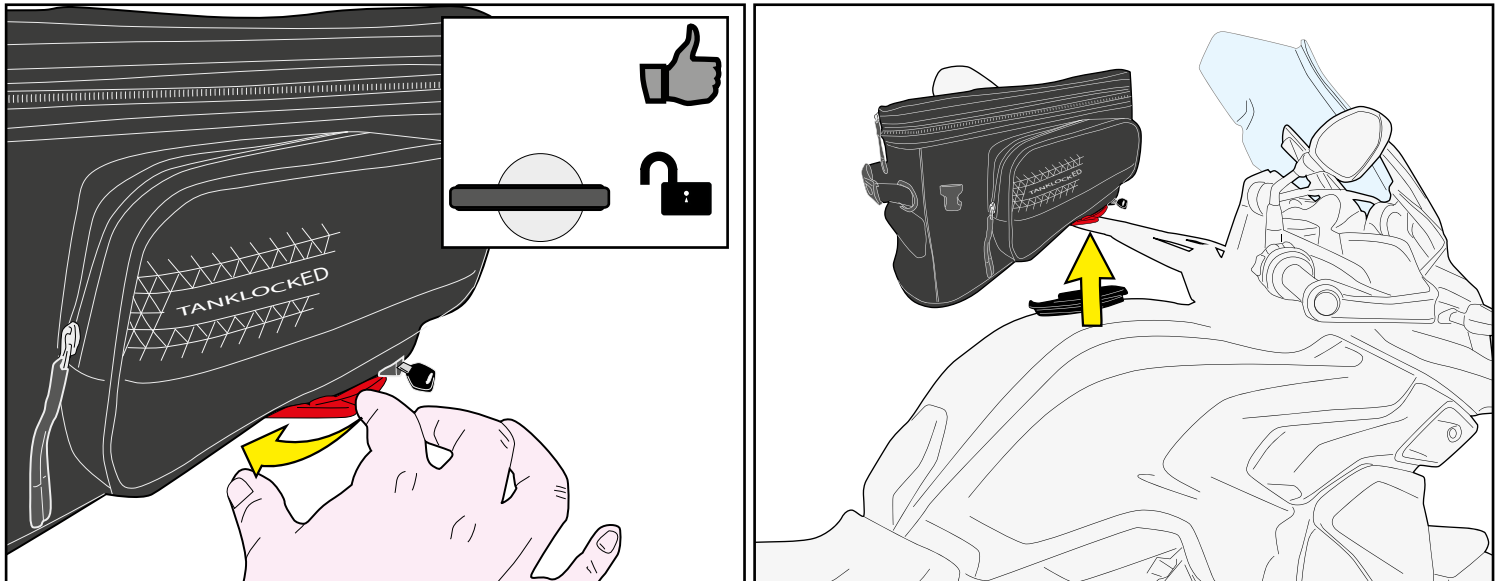

Con la chiave girata in posizione orizzontale ovvero di apertura, è possibile rimuovere la borsa dalla flangia sulla moto. (Vedi Fig.)

With the key turned horizontally (in the open position), it is possible to remove the bag from the flange on the bike. (See image)

Quand la clef est tournée horizontalement (dans la position ouverte), il est possible de décrocher la sacoche de la bride qui est sur la moto (voir photo)

Con la llave girada en posición horizontal de apertura, es posible quitar la bolsa del aro de la moto. (Ver Fig.)

Wenn der Schlüssel horizontal gedreht wird (in geöffneter Position), können Sie die Tasche vom Befestigungsring am Motorrad entfernen. (s. Abbildung)

Com a chave na posição horizontal ( posição aberta), é possível remover a bolsa da flange na motocicleta. (Veja a imagem)

- VERIFICARE ATTENTAMENTE CHE LA BORSA NON PREGIUDICHI L'ORIGINARIA GUIDABILITÀ DEL MEZZO, FACENDO PARTICOLARE ATTENZIONE AD EVENTUALI INTERFERENZE CON IL MANUBRIO.
- PLEASE CHECK CAREFULLY THAT THE BAG WILL NOT EFFECT THE ORIGINAL DRIVEABILITY, PAYING PARTICULAR ATTENTION TO ANY POSSIBLE INTERFERENCE WITH THE HANDLEBARS.
- BITTE PRÜFEN SIE DASS DIESES MODELL DIE ORIGINALFAHRT DES FAHRZEUGES NICHT BEEINTRÄCHTIGT. WIR BITTEN SIE AUF EVENTUELLE STÖRUNGEN AN DEM LENKER BESONDERS ZU ACHTEN.
- VEUILLEZ VÉRIFIER SOIGNEUSEMENT QUE LA SACOCHE N'AFFECTERA PAS LA MANIABILITÉ DU VÉHICULE, EN ACCORDANT UNE ATTENTION PARTICULIÈRE À TOUTE INTERFÉRENCE POSSIBLE AVEC LE GUIDON.
- VERIFICAR ATENTAMENTE QUE LA BOLSA NO PERJUDIQUE LA ORIGINAL CONDUCCIÓN DEL VEHÍCULO, PRESTANDO ESPECIAL ATENCIÓN A UNA EVENTUAL INTERFERENCIA CON EL MANILLAR.
- VERIFICAR CUIDADOSAMENTE QUE A BOLSA NÃO PREJUDIQUE A CONDUÇÃO ORIGINAL DO VEICULO, COM ATENÇÃO ESPECIAL EM INTERFERÊNCIAS EVENTUAL NO GUIDÃO DA MOTOCICLETA.

# UT810

BORSA DA SERBATOIO TANKLOCKED - TANKLOCKED BAG - SACOCHE DE RÉSERVOIR TANKLOCKED  
TANKRUCKSACK TANKLOCKED - BOLSA DE SOBREDEPOSITO TANKLOCKED - BOLSA DE TANQUE TANKLOCKED

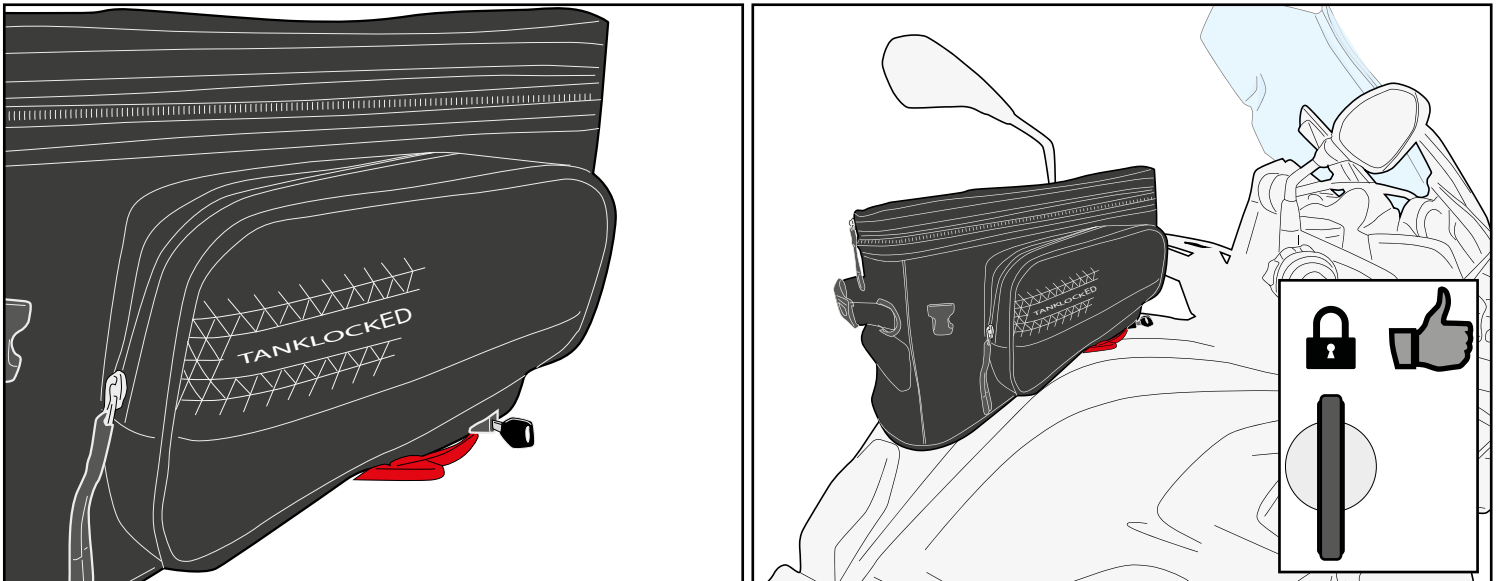

Con la chiave girata in posizione verticale ovvero di chiusura, non è possibile rimuovere la borsa dalla flangia sulla moto. (Vedi Fig.)

With the key turned vertically (in the closed position), it is not possible to remove the bag from the flange on the bike. (See image)

Quand la clef est tournée verticalement (en position fermée) , il n'est pas possible de décrocher la sacoche de la bride ( voir photo)

Con la llave girada en posición vertical de cierre, no es posible quitar la bolsa del aro de la moto. (Ver Fig.)

Wenn der Schlüssel vertikal gedreht wird (in geschlossener Position), können Sie die Tasche vom Befestigungsring am Motorrad nicht entfernen. (s. Abbildung)

Com a chave na posição vertical (posição fechada), não é possível remover a bolsa da flange na motocicleta. (Veja a imagem)

# UT810

BORSA DA SERBATOIO TANKLOCKED - TANKLOCKED BAG - SACOCHE DE RÉSERVOIR TANKLOCKED  
TANKRUCKSACK TANKLOCKED - BOLSA DE SOBREDEPOSITO TANKLOCKED - BOLSA DE TANQUE TANKLOCKED

## REMOVE INNER BAG

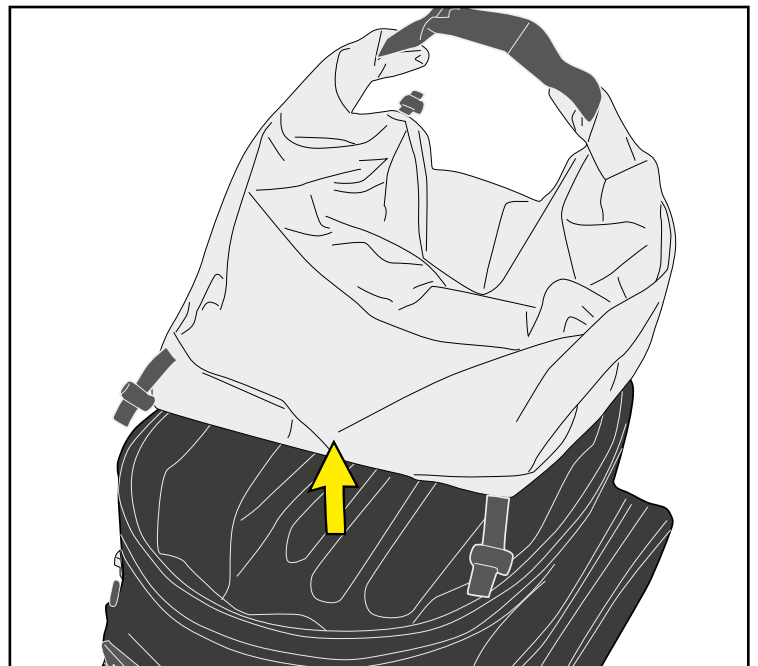
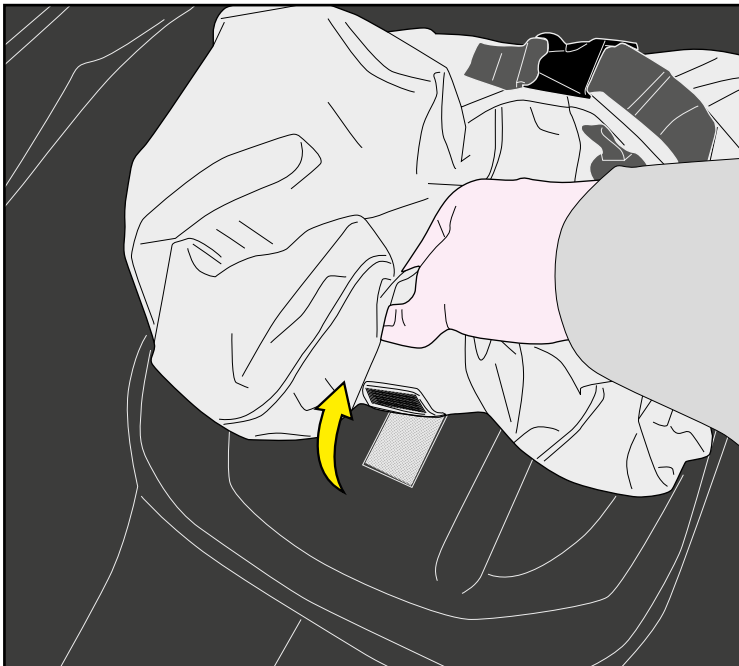
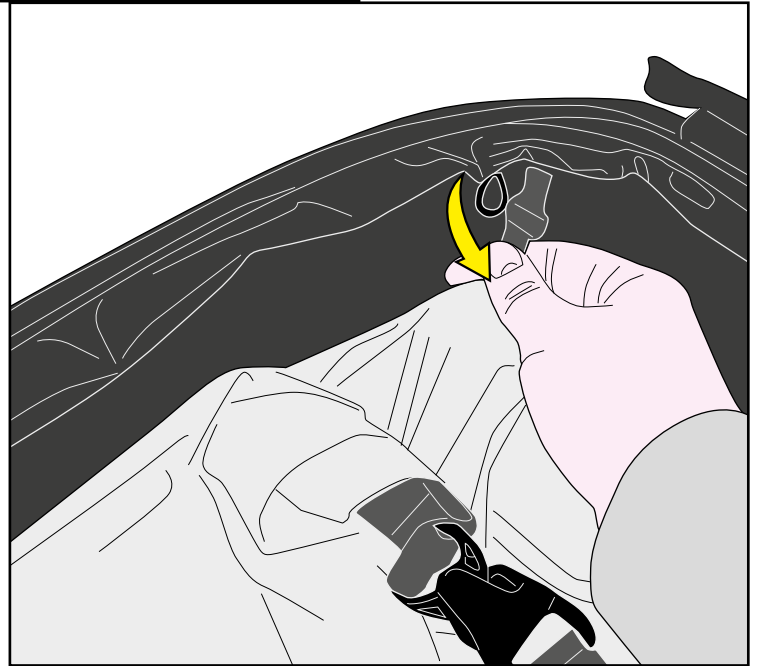
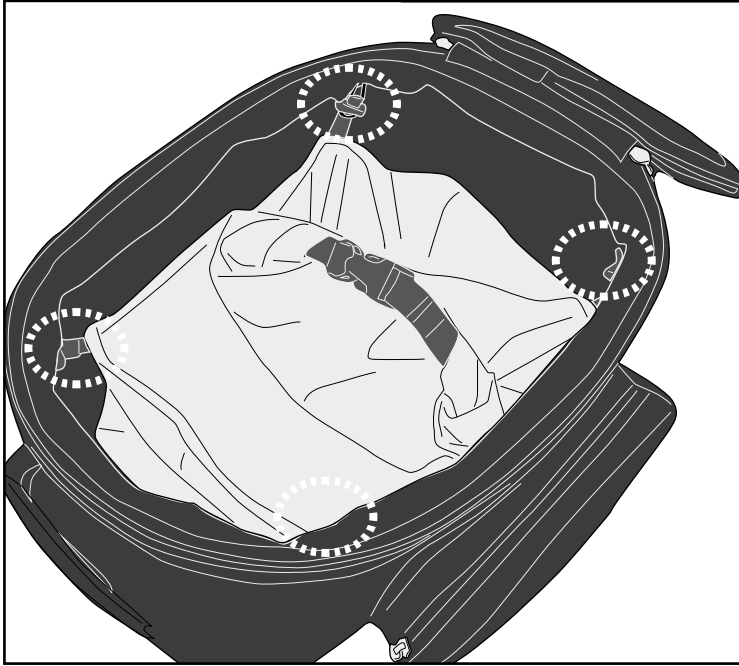

- LA COPERTINA ANTIPIOGGIA SERVE PER PROTEGGERE DALL'ACQUA LE TASCHE LATERALI E LA PICCOLA FINESTRA TRASPARENTE SUPERIORE, CHE A DIFFERENZA DEL VANO PRINCIPALE NON SONO IMPERMEABILI.
- THE RAIN COVER IS USED TO PROTECT FROM THE WATER THE SIDE POCKETS AND THE SMALL TRANSPARENT TOP WINDOW, WHICH, UNLIKE THE MAIN COMPARTMENT, ARE NOT WATERPROOF.
- DIE REGENHÜLLE SCHÜTZT DIE SEITENTASCHEN UND DAS KLEINE DURCHSICHTIGE OBERE FENSTER VOR DEM WASSER, WELCHE IM GEGENSATZ ZUM REST NICHT WASSERDICHT SIND.
- LA HOUSSE DE PLUIE EST UTILISÉE POUR PROTÉGER DE L'EAU LES POCHEs LATÉRALES ET LA PETITE FENÊTRE TRANSPARENTE DU DESSUS QUI, AU CONTRAIRE DU COMPARTIMENT CENTRAL, NE SONT PAS ÉTANCHES.
- LA FUNDA RESISTENTE AL AGUA SIRVE PARA PROTEGER DEL AGUA LOS BOLSILLOS LATERALES Y LA PEQUEÑA VENTANA TRANSPARENTE SUPERIOR, QUE A DIFERENCIA DEL COMPARTIMENTO PRINCIPAL NO SON IMPERMEABLES.
- A CAPA DE CHUVA É UTILIZADA PARA PROTEGER DA AGUA OS BOLSOS LATERAIS E A JANELA TRANSPARENTE NO TOPO, QUE DIFERENTEMENTE DA BOLSA PRINCIPAL, NÃO SÃO IMPERMEÁVEL.

# UT810

BORSA DA SERBATOIO TANKLOCKED - TANKLOCKED BAG - SACOCHE DE RÉSERVOIR TANKLOCKED  
TANKRUCKSACK TANKLOCKED - BOLSA DE SOBREDEPOSITO TANKLOCKED - BOLSA DE TANQUE TANKLOCKED

## MOUNTING TABLET/MAP HOLDER

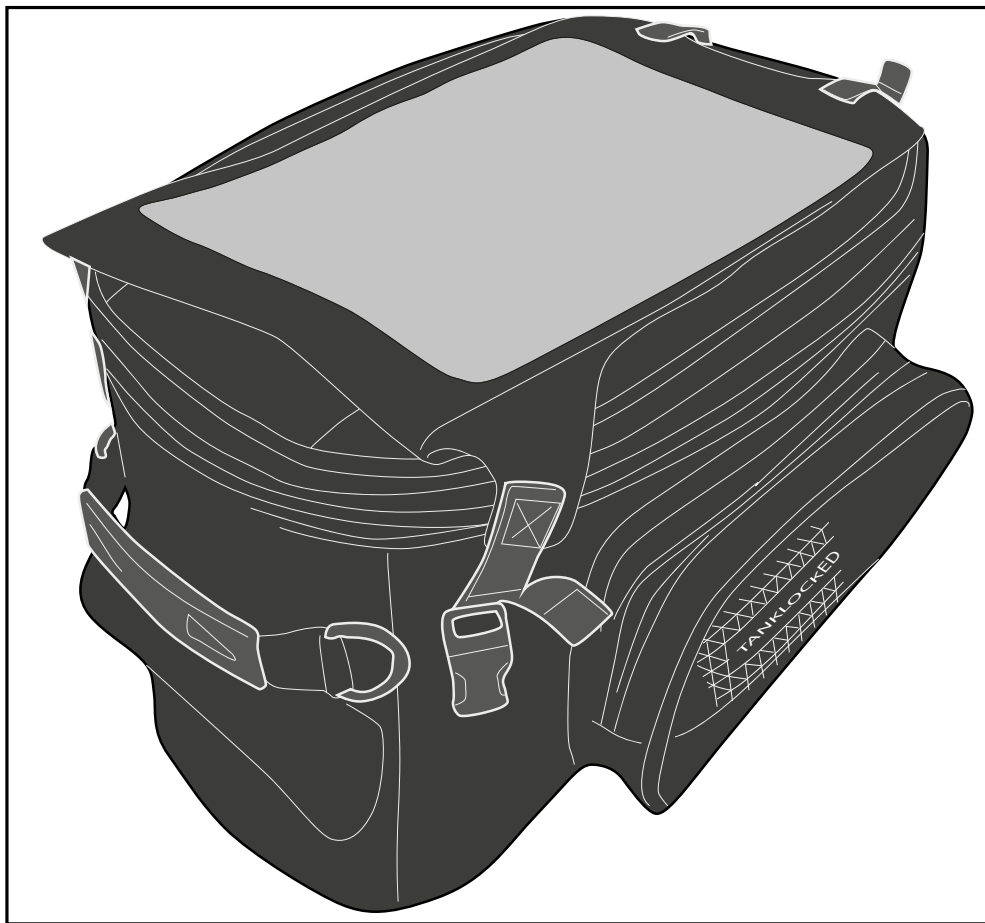
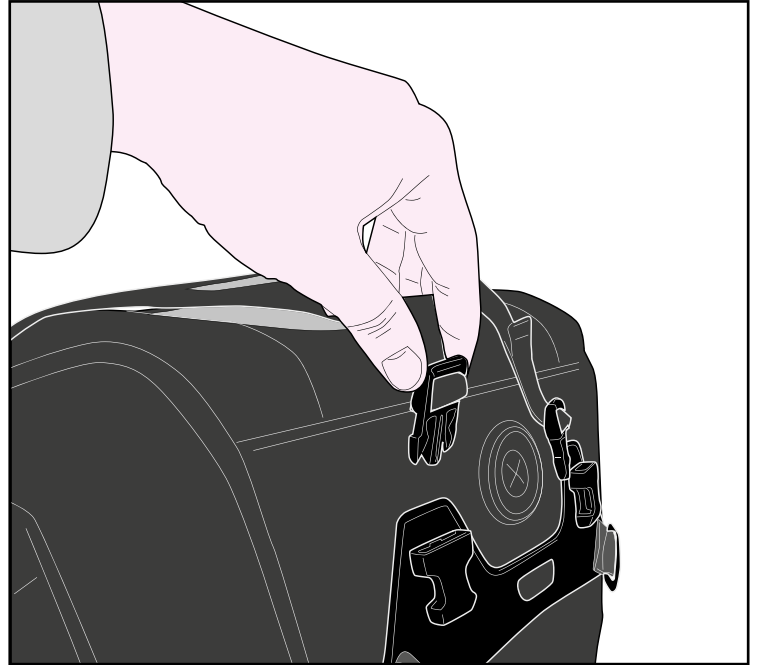
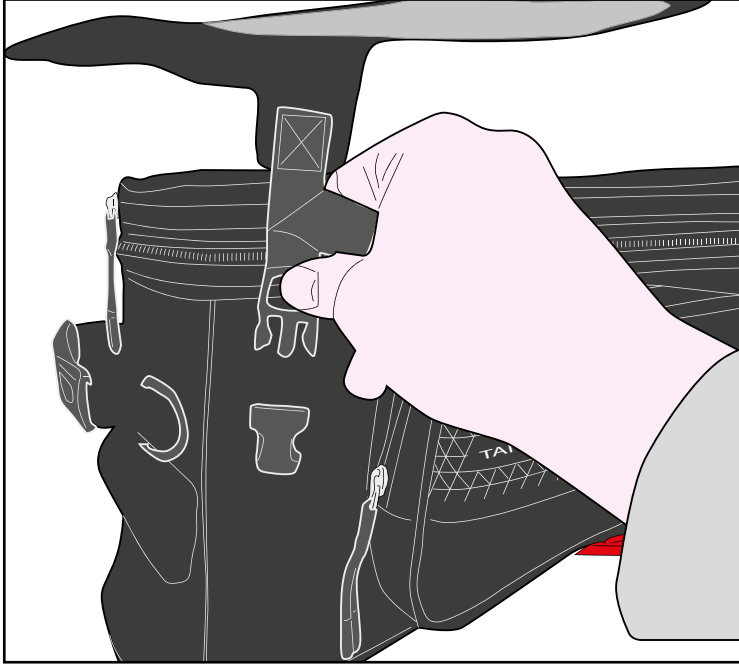

# UT810

BORSA DA SERBATOIO TANKLOCKED - TANKLOCKED BAG - SACOCHE DE RÉSERVOIR TANKLOCKED  
TANKRUCKSACK TANKLOCKED - BOLSA DE SOBREDEPOSITO TANKLOCKED - BOLSA DE TANQUE TANKLOCKED



+

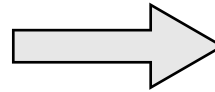
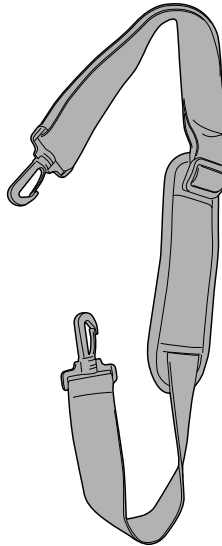

# UT810

BORSA DA SERBATOIO TANKLOCKED – TANKLOCKED BAG – SACOCHE DE RÉSERVOIR TANKLOCKED  
TANKRUCKSACK TANKLOCKED – BOLSA DE SOBREDEPOSITO TANKLOCKED – BOLSA DE TANQUE TANKLOCKED

---

**IT: Avvertenze per l'uso del porta dispositivo removibile GIVI**

Rispettate i limiti di temperatura forniti dal costruttore per il corretto funzionamento del vostro dispositivo elettronico Smartphone – Tablet – Navigatore.

Attenzione! un' esposizione prolungata al sole potrebbe danneggiare seriamente il vostro dispositivo. Givi S.r.l. non risponde per i danni provocati dall'inosservanza di tali limiti e dal cattivo uso del prodotto.

**EN: Important warning for the use of the GIVI removable device holder**

To avoid possible malfunctions, please always operate your electronic device (smartphone, GPS navigator, tablet etc) within the temperature limits specified by the device's manufacturer.

**WARNING:** any extended exposure to direct sunlight may result in permanent damage to your device. GIVI S.r.l. cannot be hold responsible for any damage deriving from an improper use of the device holder and/or failing to observe the operating temperature limitations specified by the manufacturer of the electronic device.

**FR: Avertissement important pour l'utilisation du support smartphone GIVI**

Pour éviter d'éventuels dysfonctionnements, utilisez toujours votre appareil électronique (smartphone, navigateur GPS, tablette, etc.) dans les limites de température spécifiées par le fabricant de l'appareil.

**AVERTISSEMENT :** toute exposition prolongée à la lumière directe du soleil peut entraîner des dommages permanents sur votre appareil. GIVI S.r.l. ne peut être tenu responsable des dommages résultants d'une utilisation incorrecte du support de l'appareil et/ ou du non-respect des limites de température de fonctionnement spécifiées par le fabricant de l'appareil électronique.

**ES: Advertencia para el uso del porta dispositivo extraíble GIVI**

Respetar los límites de temperatura proporcionados del fabricante para el correcto funcionamiento de vuestro dispositivo electrónico Smartphone – Tablet – Navegador.

Atención! Una exposición prolongada al sol puede dañar seriamente vuestro dispositivo.

Givi no responde por los daños provocados de la inobservancia de tales límites y del mal uso del producto.

**DE: Wichtiger Hinweis für die Verwendung der abnehmbaren GIVI Halterungen**

Bitte beachten Sie die vom Hersteller vorgeschriebenen Temperaturgrenzen für den Betrieb Ihrer elektronischen Geräte (Smartphone, GPS Navigation, Tablet etc.).

**ACHTUNG:** jede längere direkte Sonneneinstrahlung kann zu dauerhaften Schäden an Ihrem Gerät führen. GIVI S.r.l. haftet nicht für Schäden, die durch den unsachgemäßen Gebrauch der Halterung und/oder bei Nichteinhaltung der vom Hersteller vorgeschriebenen Temperaturgrenzen der Geräte entstehen.

**PT: Aviso importante para o uso do suporte de dispositivo removível GIVI**

Para evitar possíveis avarias, utilize sempre o seu dispositivo eletrónico (smartphone, navegador GPS, tablet, etc.) dentro dos limites de temperatura especificados pelo fabricante do dispositivo.

**AVISO:** qualquer exposição prolongada à luz solar direta pode resultar em danos permanentes ao seu dispositivo. GIVI S.r.l. Não pode ser responsabilizada por quaisquer danos resultantes de uma utilização inadequada do suporte do dispositivo e / ou não observar as limitações de temperatura de funcionamento especificadas pelo fabricante do dispositivo eletrónico.