

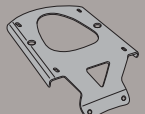

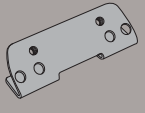







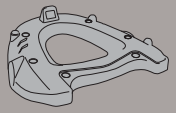



SR6703 - KR6703

PORTAPACCO SPECIFICO - SPECIFIC HOLDER - PORTE-PAQUET SPÉCIFIQUE - SPEZIFISCHER TRÄGER - PORTA-EQUIPAJE ESPECÍFICO

APRILIA SRV850 (2012)

N°	Descrizione	Caratteristiche	Codice	Quantità	
1	Supporto - Support - Support Halierung - Soporte	sp. 3mm	GL2181	1	
2	Supporto - Support - Support Halierung - Soporte	sp. 3mm	GL2180	1	
3	Supporto - Support - Support Halierung - Soporte			2 (Dx;Sx)	
4	Piastra - Plate Platine - Platte Parrilla	M5	Z622M	1	
5	Vite - Screw Vis - Schraube Tornillo	TEF M8x30	830TEF	2	
6	Vite - Screw Vis - Schraube Tornillo	TCEI M6x16	616TCE	2	
7	Vite - Screw Vis - Schraube Tornillo	TCEI M6x40	640TCE	2	
8	Vite - Screw Vis - Schraube Tornillo	TCEI M6x25	625TCE	4	
9	Vite - Screw Vis - Schraube Tornillo	TBEI M8x30	830TBEI	2	
10	Vite - Screw Vis - Schraube Tornillo	TSCEI M8x20	820TSP	2	
11	Rondella - Washer Rondelle - Scheibe Arandela	Ø6	6RON	8	
12	Rondella - Washer Rondelle - Scheibe Arandela	Ø8	8RONZ	2	
13	Rondella - Washer Rondelle - Scheibe Arandela	Ø8x14	814RON	2	
14	Rondella - Washer Rondelle - Scheibe Arandela	Ø6x18	618RON	4	
15	Distanziale - Spacer Entretoise - Distanzstueck Distanciador	Ø18x12 foro 8.5 mm	B021	4	

SR6703 - KR6703

PORTAPACCO SPECIFICO - SPECIFIC HOLDER - PORTE-PAQUET SPÉCIFIQUE - SPEZIFISCHER TRÄGER - PORTA-EQUIPAJE ESPECÍFICO

APRILIA SRV850 (2012)

N°	Descrizione	Caratteristiche	Codice	Quantità	
16	Dado - Bolt - Ecrou Mutter - Tuerca	Auto Bloccante M6	6DADIAU	4	
17	Copriforo - Bolt Cap Cache Trou - Stopslock Tapa Agujero		Z621	6	



SR6703 - KR6703

PORTAPACCO SPECIFICO - SPECIFIC HOLDER - PORTE-PAQUET SPÉCIFIQUE - SPEZIFISCHER TRÄGER - PORTA-EQUIPAJE ESPECÍFICO

APRILIA SRV850 (2012)

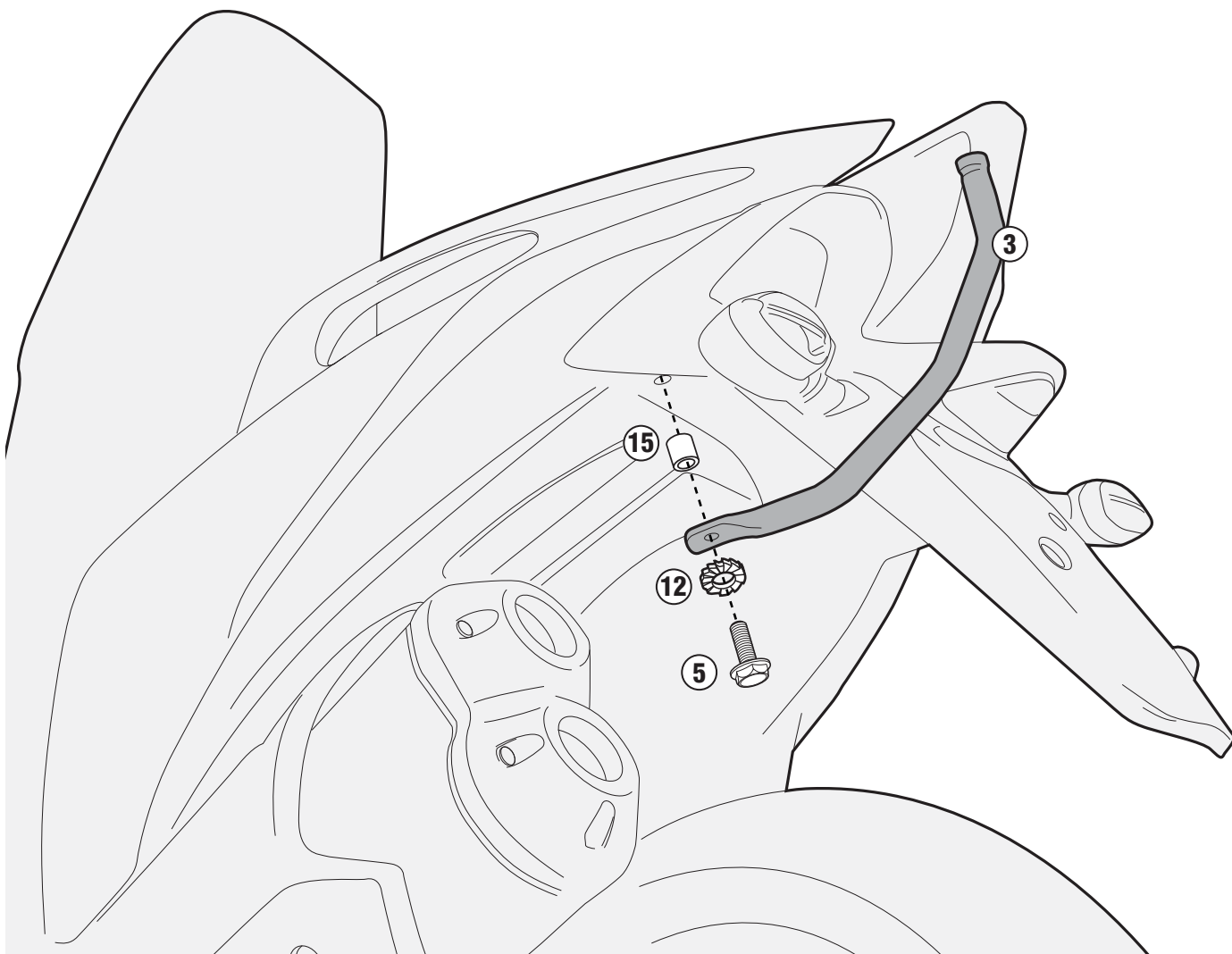
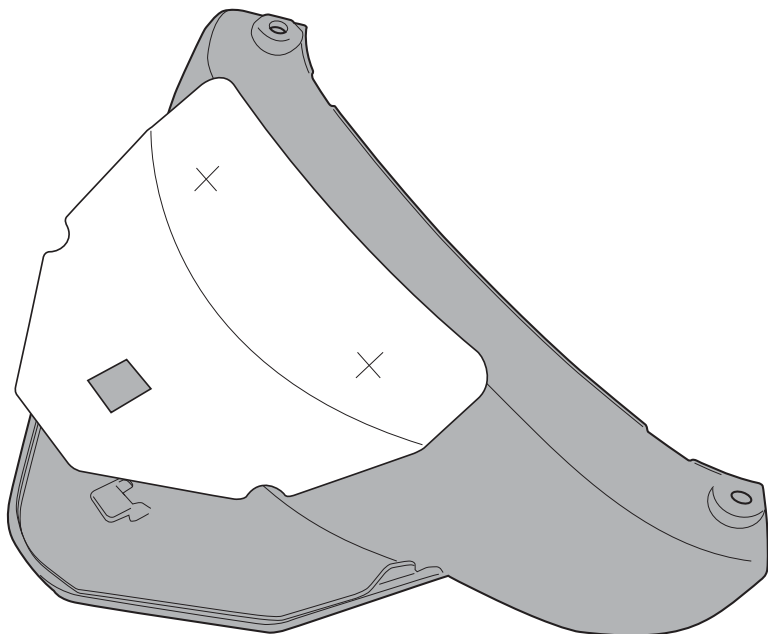

ISTRUZIONI DI MONTAGGIO - MOUNTING INSTRUCTIONS
INSTRUCTIONS DE MONTAGE - BAUANLEITUNG - INSTRUCCIONES
DE MONTAJE

SR6703 - KR6703

PORTAPACCO SPECIFICO - SPECIFIC HOLDER - PORTE-PAQUET SPÉCIFIQUE - SPEZIFISCHER TRÄGER - PORTA-EQUIPAJE ESPECÍFICO

APRILIA SRV850 (2012)

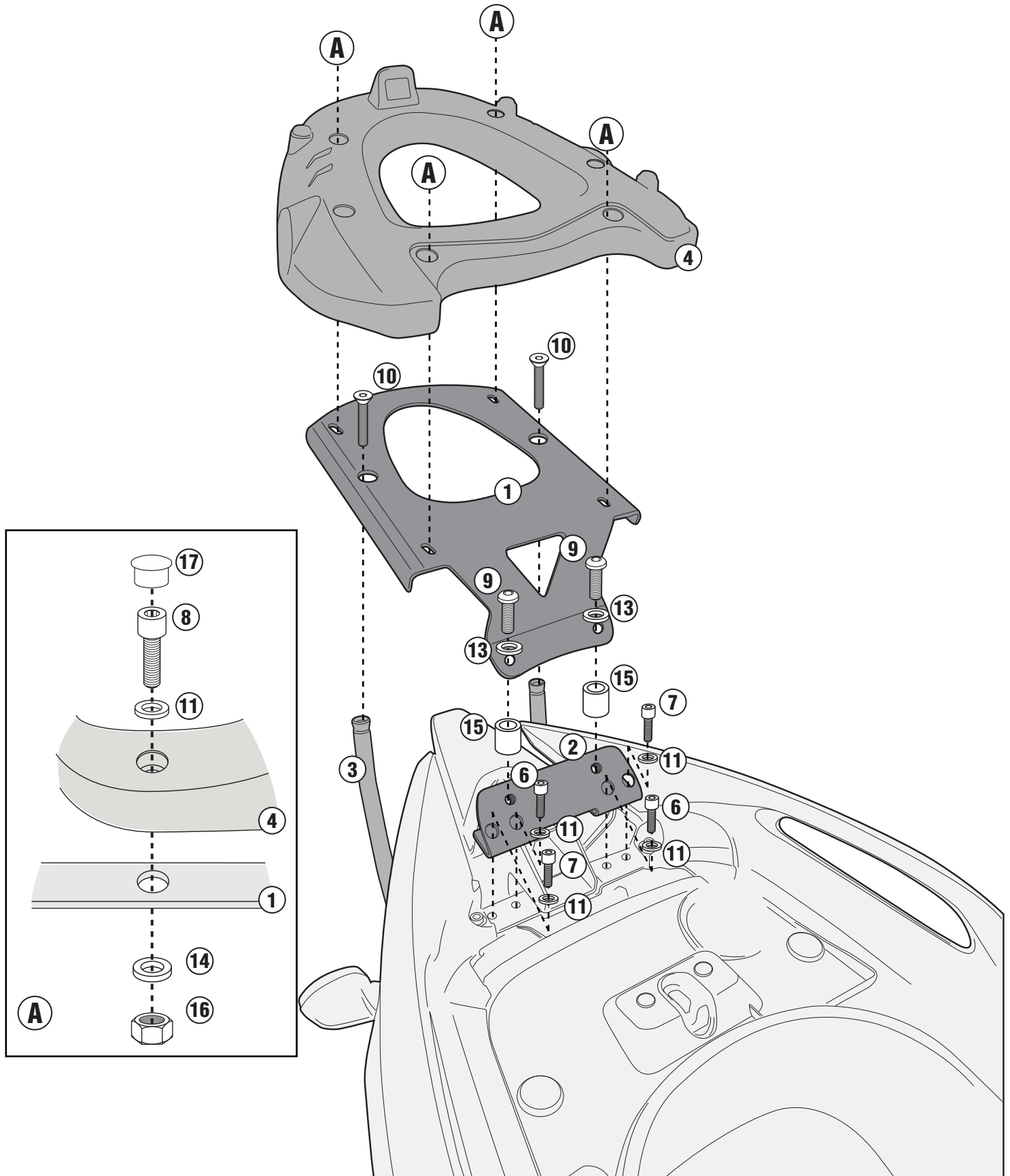

ISTRUZIONI DI MONTAGGIO - MOUNTING INSTRUCTIONS
INSTRUCTIONS DE MONTAGE - BAUANLEITUNG - INSTRUCCIONES
DE MONTAJE

SR6703 - KR6703

PORTAPACCO SPECIFICO - SPECIFIC HOLDER - PORTE-PAQUET SPÉCIFIQUE - SPEZIFISCHER TRÄGER - PORTA-EQUIPAJE ESPECÍFICO

APRILIA SRV850 (2012)

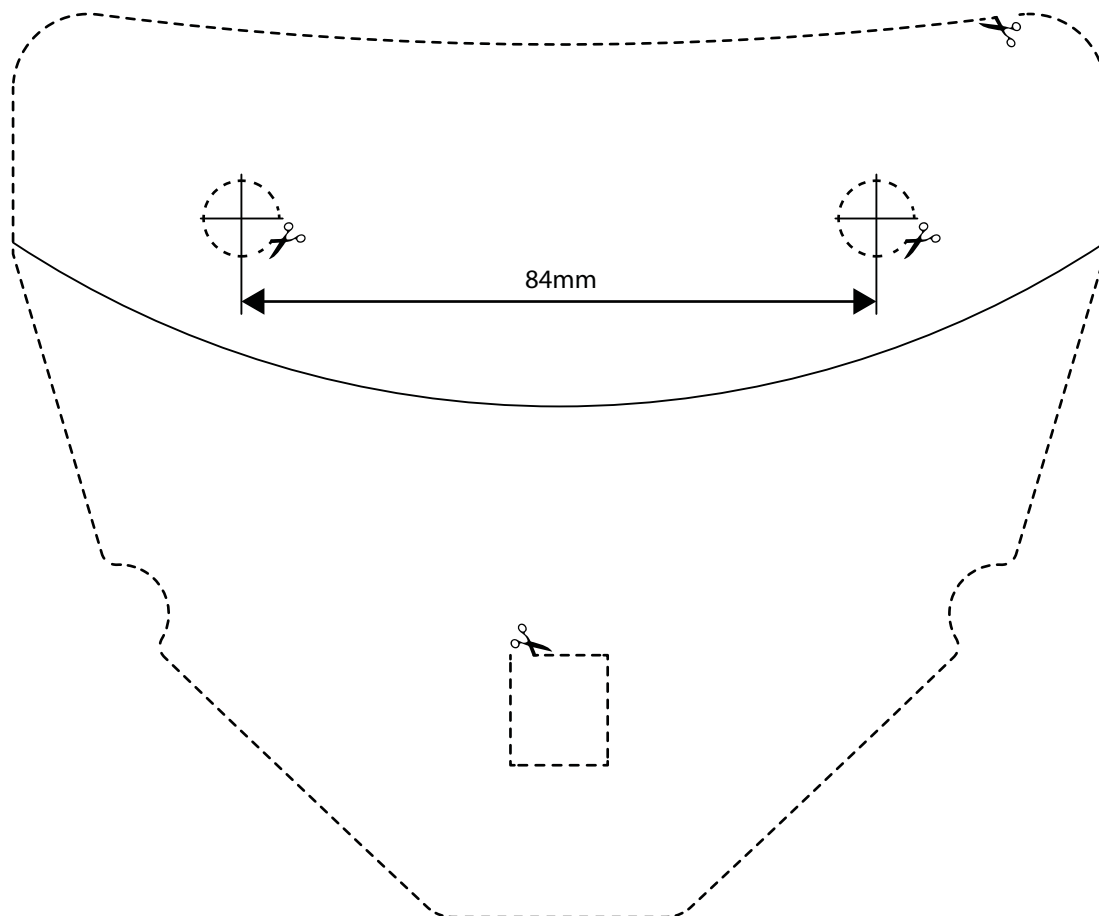

PRIMA DI FORARE VERIFICARE CHE LA DIMA CORRISPONDA ALLE MISURE INDICATE

BEFORE DRILLING HOLES CHECK THAT MEASURES ON TEMPLATE CORRESPOND

AVANT DE PERCER CONTROLER QUE LE GABARIT CORRESPOND AUX MESURES INDIQUEE

BEVOR DER KOFFERDECKEL DURCHBOHRT WIRD, PRÜFEN SIE DAß DIE SCHABLONE DEN GEGEBENEN ABMESSUNGEN ENTSPRICHT

ANTES DE HACER LOS AGUJEROS COMPROBAR LAS MEDIDAS DE LA PLANTILLA CORRESPONIENTE