

PLX1150 - KLX1150

PORTAVALIGIE LATERALE SPECIFICO - SPECIFIC TUBULAR SIDE-CASE HOLDER - PORTE-VALISES LATÉRAUX SPÉCIFIQUE - SPEZIFISCHES STAHLROHR-SEITENTRAEGER
PORTA MALETAS LATERALES ESPECÍFICO

HONDA INTEGRA 750 (2016)

N°	Descrizione	Caratteristiche	Codice	Quantità
1	Telaio laterale - Side frame - Châssis latéral - Soporte lateral - Seitenrahmen - Suporte lateral	-	PLX1150 (Dx - Sx)	2 (Dx,Sx)
2	Ponte Posteriore - Rear Bridge - Pont Postérieure Verbindungsrohr - Puente Trasero	-	GNB1568P	1
3	Vite - Screw Vis - Schraube Tornillo - Parafuso	TEF M8x16	816TEF	6
4	Vite - Screw Vis - Schraube Tornillo - Parafuso	TBEI M8x16	816TBEI	2
5	Vite - Screw Vis - Schraube Tornillo - Parafuso	TBEI M8x20	820TBEI	2
6	Rondella - Washer - Rondelle Scheibe - Arandela - Arruela	-	Z1060	4
7	Particolari Inclusi Nell'SR1150 Components Included In The SR1150 Pièces Inclues Dans El SR1150 Bestandteile im SR1150 enthalten Despieces Incluidos En El SR1150 Explodiu incluído da SR1150	-	-	-

PLX1150 - KLX1150

PORTAVALIGIE LATERALE SPECIFICO - SPECIFIC TUBULAR SIDE-CASE HOLDER - PORTE-VALISES LATÉRAUX SPÉCIFIQUE - SPEZIFISCHES STAHLROHR-SEITENTRAEGER

PORTA MALETAS LATERALES ESPECÍFICO

HONDA INTEGRA 750 (2016)

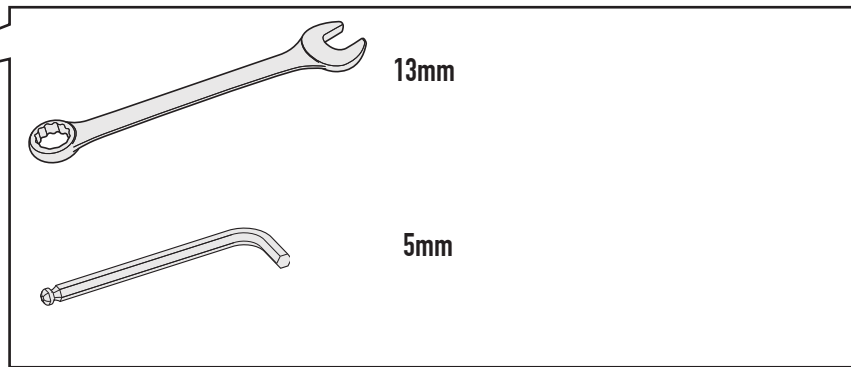
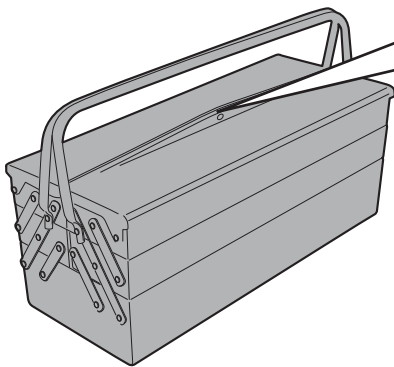
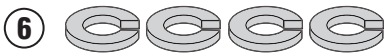
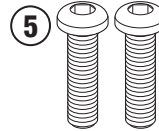
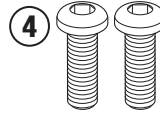
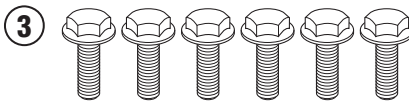
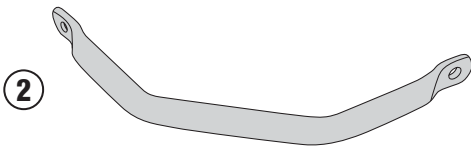
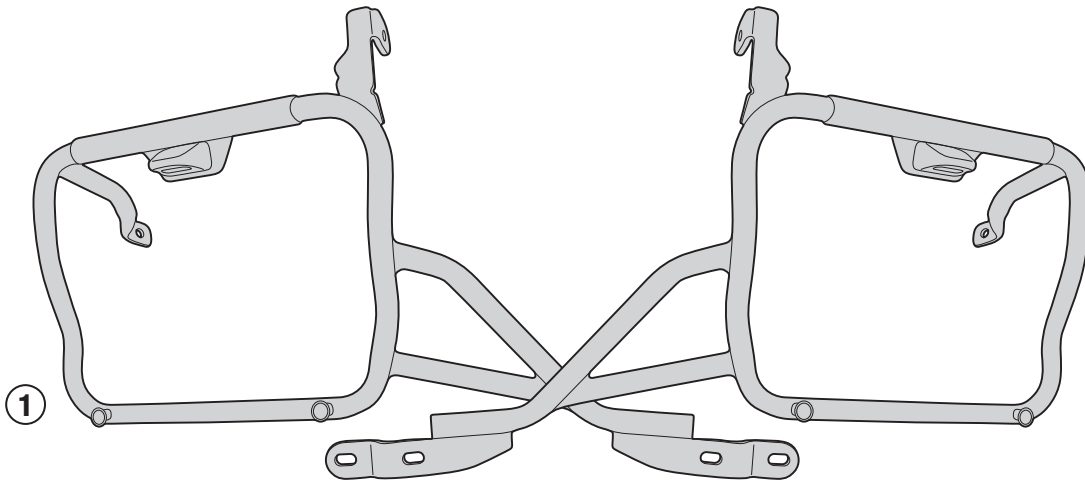

ISTRUZIONI DI MONTAGGIO - MOUNTING INSTRUCTIONS
INSTRUCTIONS DE MONTAGE - BAUANLEITUNG
INSTRUCCIONES DE MONTAJE - INSTRUÇÕES DE MONTAGEM

PLX1150 - KLX1150

PORTAVALIGIE LATERALE SPECIFICO - SPECIFIC TUBULAR SIDE-CASE HOLDER - PORTE-VALISES LATÉRAUX SPÉCIFIQUE - SPEZIFISCHES STAHLROHR-SEITENTRAEGER

PORTA MALETAS LATERALES ESPECÍFICO

HONDA INTEGRA 750 (2016)

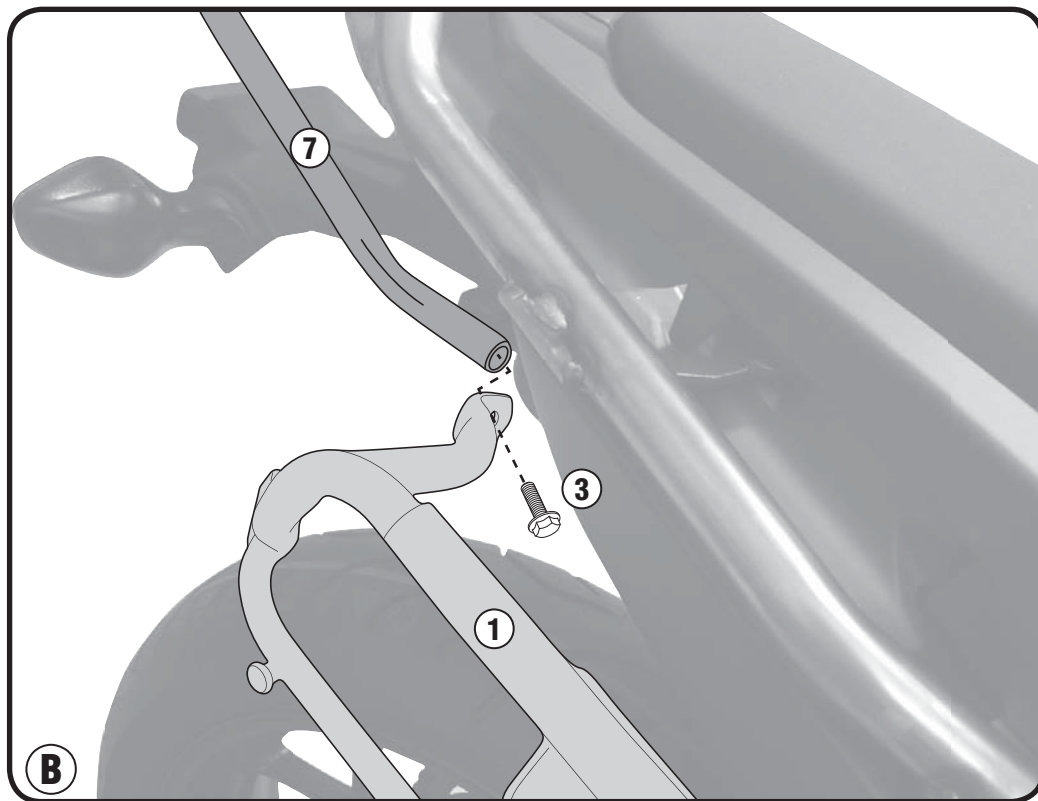
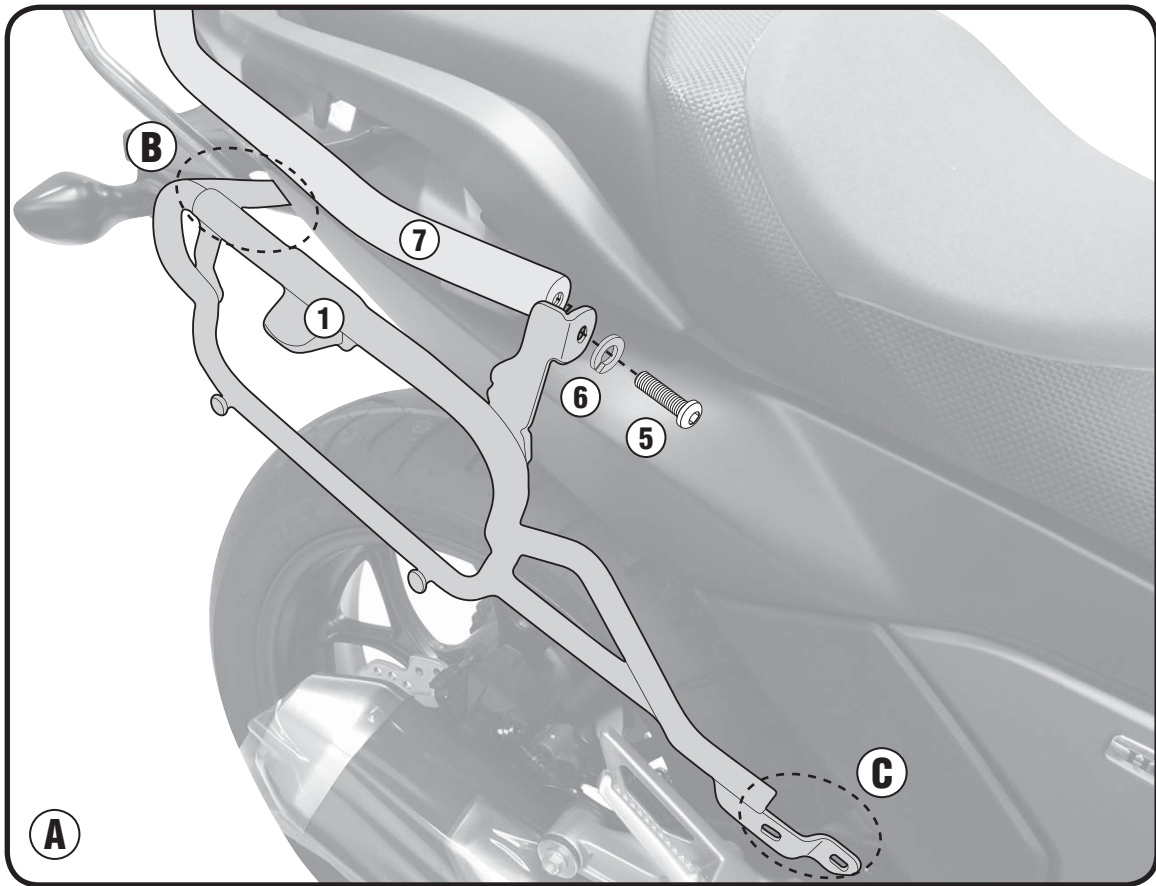

PLX1150 - KLX1150

PORTAVALIGIE LATERALE SPECIFICO - SPECIFIC TUBULAR SIDE-CASE HOLDER - PORTE-VALISES LATÉRAUX SPÉCIFIQUE - SPEZIFISCHES STAHLROHR-SEITENTRAEGER

PORTA MALETAS LATERALES ESPECÍFICO

HONDA INTEGRA 750 (2016)

