

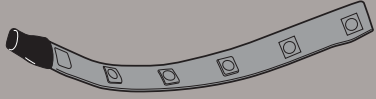

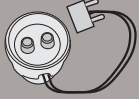



# E160

## KIT LUCI STOP PER - STOP LIGHT KIT FOR - KIT LUMIÈRE DE STOP POUR - BREMSLICHTER FÜR - KIT LUCES-STOP PARA V56 MAXIA 4 / V56 MAXIA 4 TECH

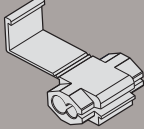
N°	Descrizione	Caratteristiche	Quantità	
1	Kit Luci Stop - Stop Light Kit - Kit Lumière De Stop - Bremslichter - Kit Luces Stop	-	2 (Dx,Sx)	
2	Contatti Fondo - Bottom For Contacts Bloc Porte-Contacteurs - Bodenkontakt Kofferöffnung Fondo Porta-Contactos	-	1	
3	Cavo Connessione Piastra Cable For Plate Connection Cable Connexion Platine Kabelkontakt Für Plattenverbindung Cable De Conexión De La Parrilla	-	1	
4	Contatti Coperchio - Cover Contacts Contacteur Couvercle - Deckelkontakt Contactos De La Tapa	-	1	
5	Derivatore di Tensione - Wiring Clamp Cosse de dérivation électrique - Kabelschnellverbinder Conector Para Circuito Eléctrico Moto	-	2	
6	Vite - Screw Vis - Schraube Tornillo	2995TSP	4	
7	Vite - Screw Vis - Schraube Tornillo	3919KNIP	2	
8	Vite - Screw Vis - Schraube Tornillo	412TBEIX	2	
9	Inserto filettato - Threaded insert - Insert filette - Buchse mit gewinde - Tacos de plástico	-	2	
10	Supporto - Support - Support Halterung - Soporte - Apoyo	-	2	
11	Porta contatti - Bottom for contacts - Bloc porte- contacteurs - Bodenkontaktkofferöffnung - Fondo porta contactos	-	1	-
12	Supporto - Support - Support Halterung - Soporte - Apoyo	-	1	

# E160

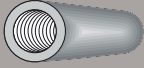
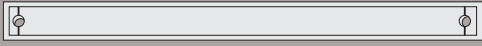
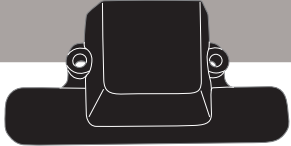
KIT LUCI STOP PER - STOP LIGHT KIT FOR - KIT LUMIÈRE DE STOP POUR - BREMSLICHTER FÜR - KIT LUCES-STOP PARA  
V56 MAXIA 4 / V56 MAXIA 4 TECH

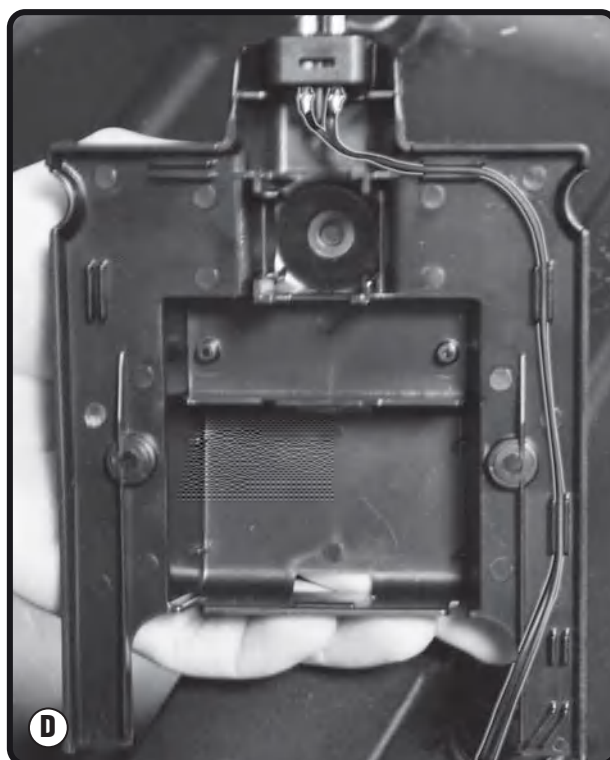
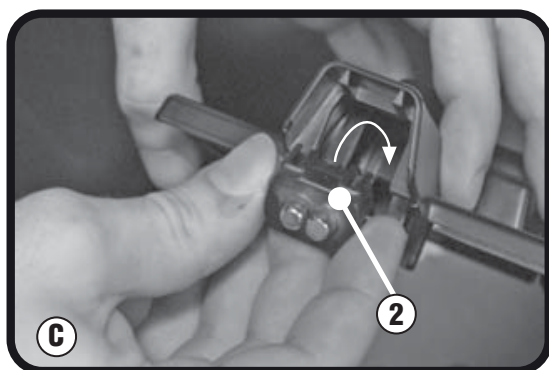
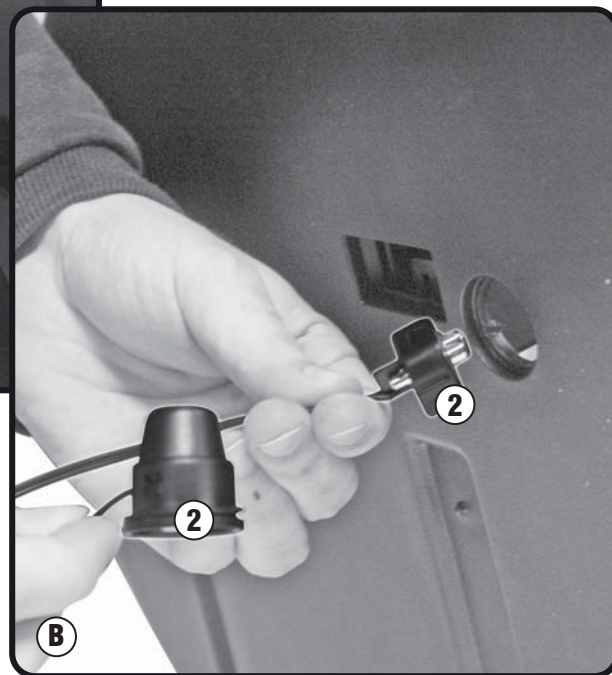

# E160

KIT LUCI STOP PER - STOP LIGHT KIT FOR - KIT LUMIÈRE DE STOP POUR - BREMSLICHTER FÜR - KIT LUCES-STOP PARA  
V56 MAXIA 4 / V56 MAXIA 4 TECH

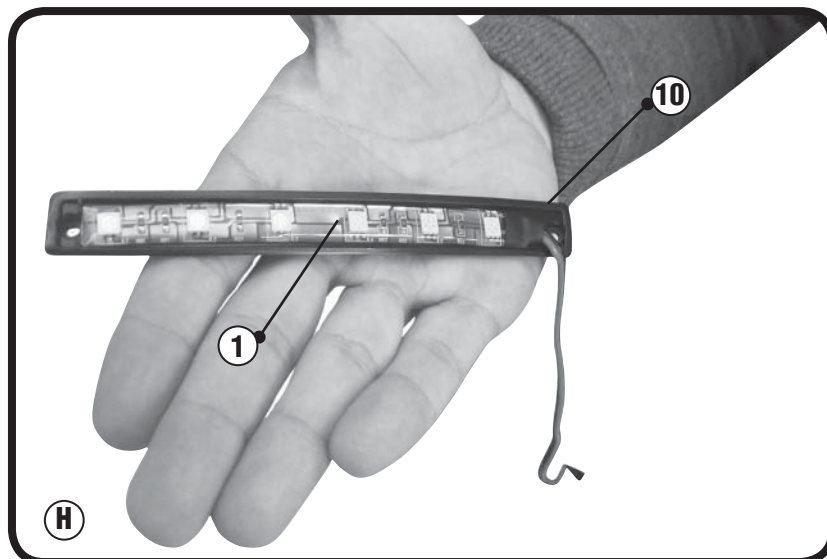
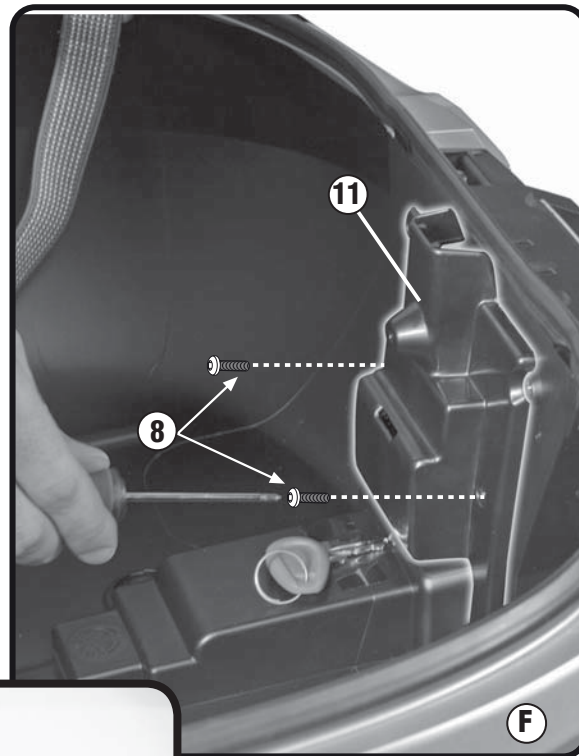
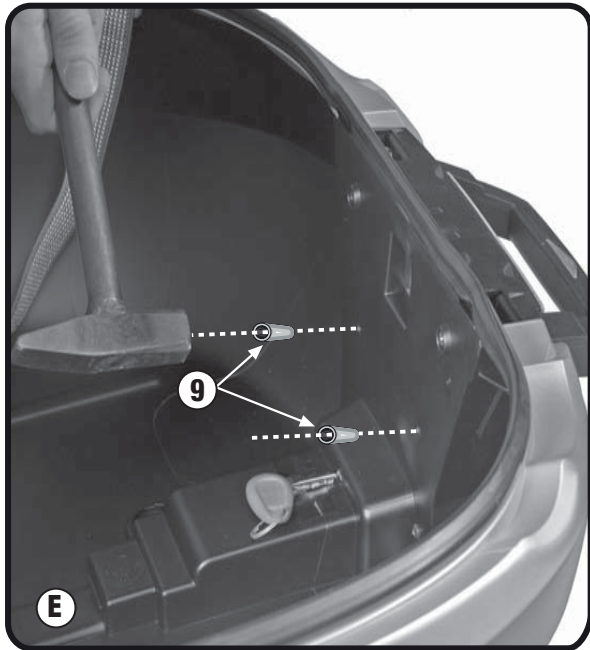

# E160

KIT LUCI STOP PER - STOP LIGHT KIT FOR - KIT LUMIÈRE DE STOP POUR - BREMSLICHTER FÜR - KIT LUCES-STOP PARA  
V56 MAXIA 4 / V56 MAXIA 4 TECH

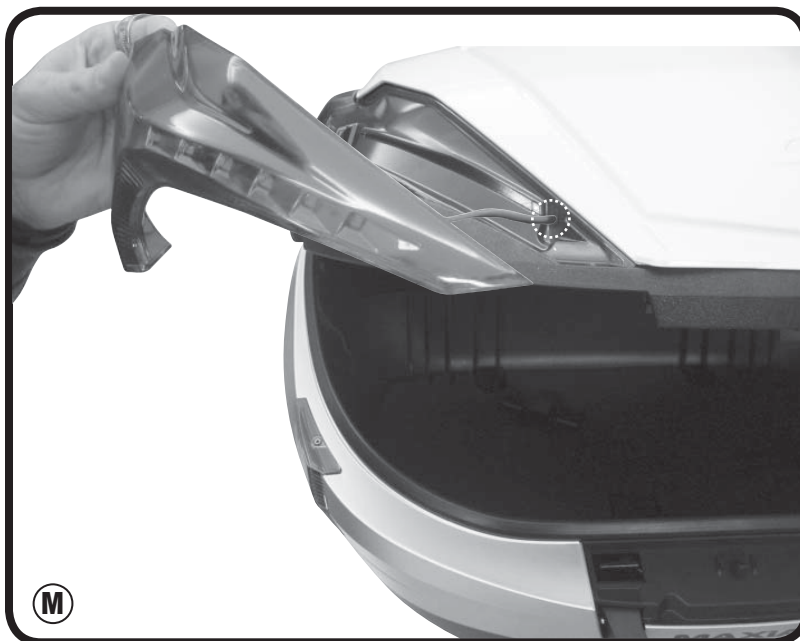
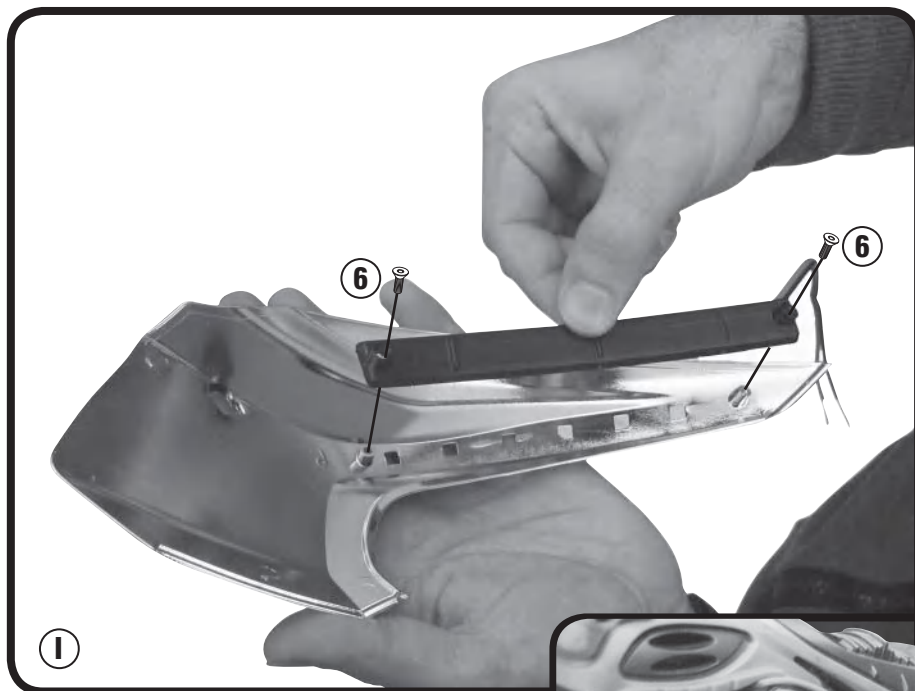

# E160

KIT LUCI STOP PER - STOP LIGHT KIT FOR - KIT LUMIÈRE DE STOP POUR - BREMSLICHTER FÜR - KIT LUCES-STOP PARA  
V56 MAXIA 4 / V56 MAXIA 4 TECH

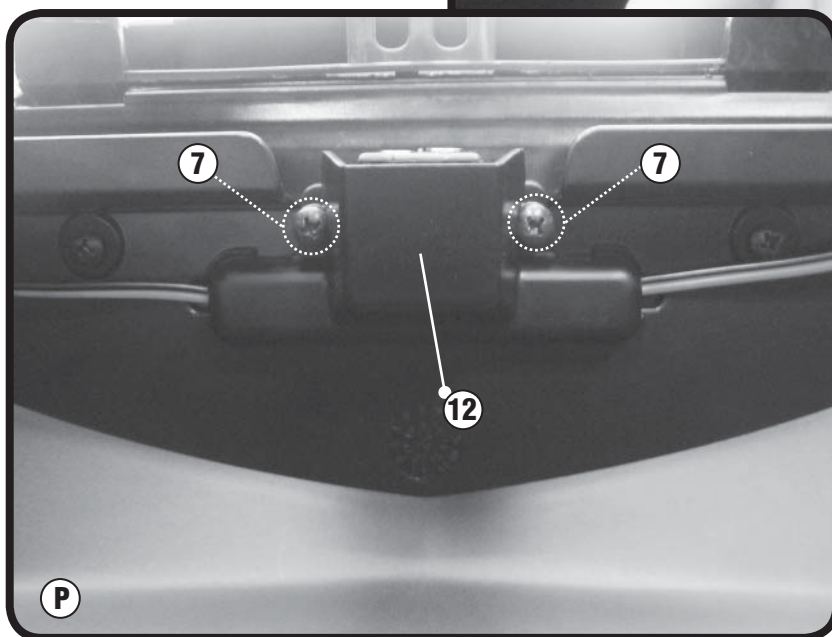
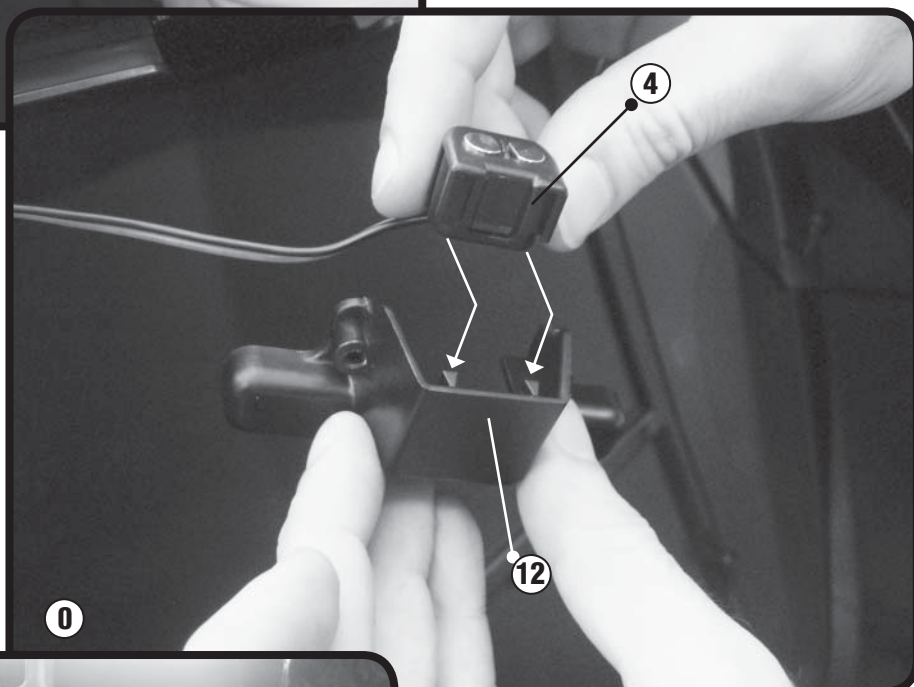
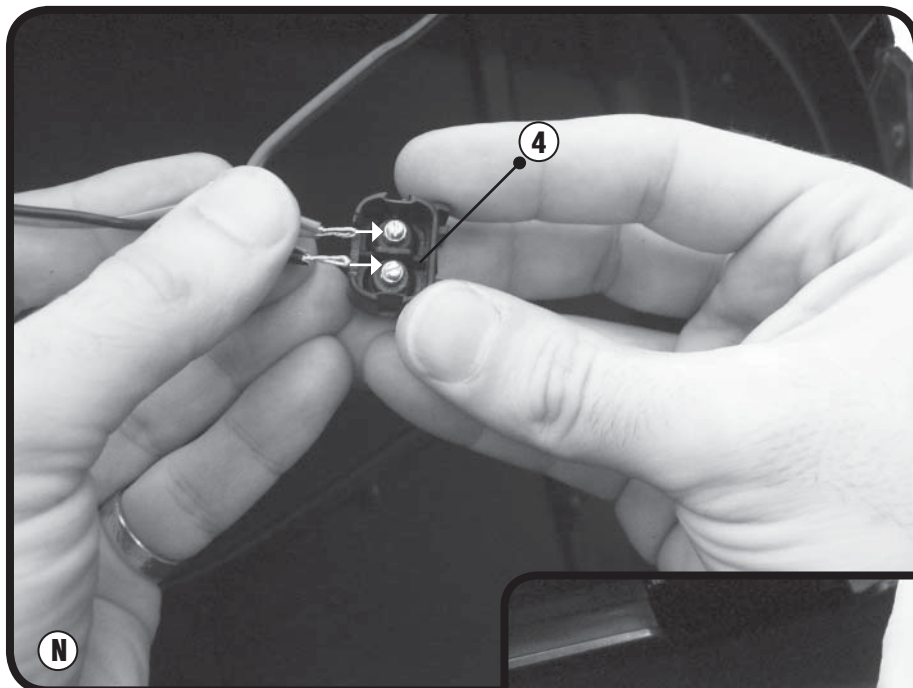

# E160

KIT LUCI STOP PER - STOP LIGHT KIT FOR - KIT LUMIÈRE DE STOP POUR - BREMSLICHTER FÜR - KIT LUCES-STOP PARA  
V56 MAXIA 4 / V56 MAXIA 4 TECH

SOLO-ONLY-NUR-SEUL-SÓLO  
E135

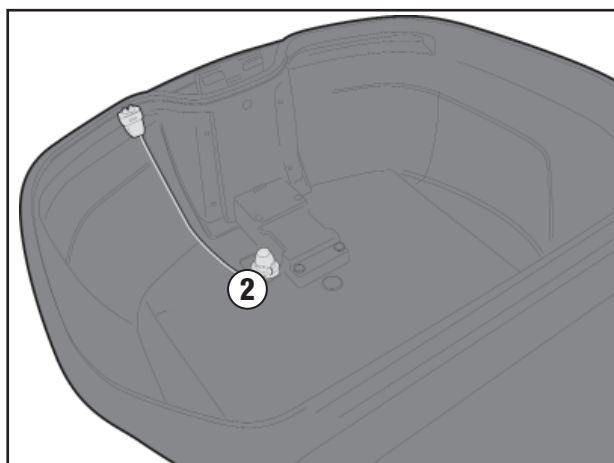
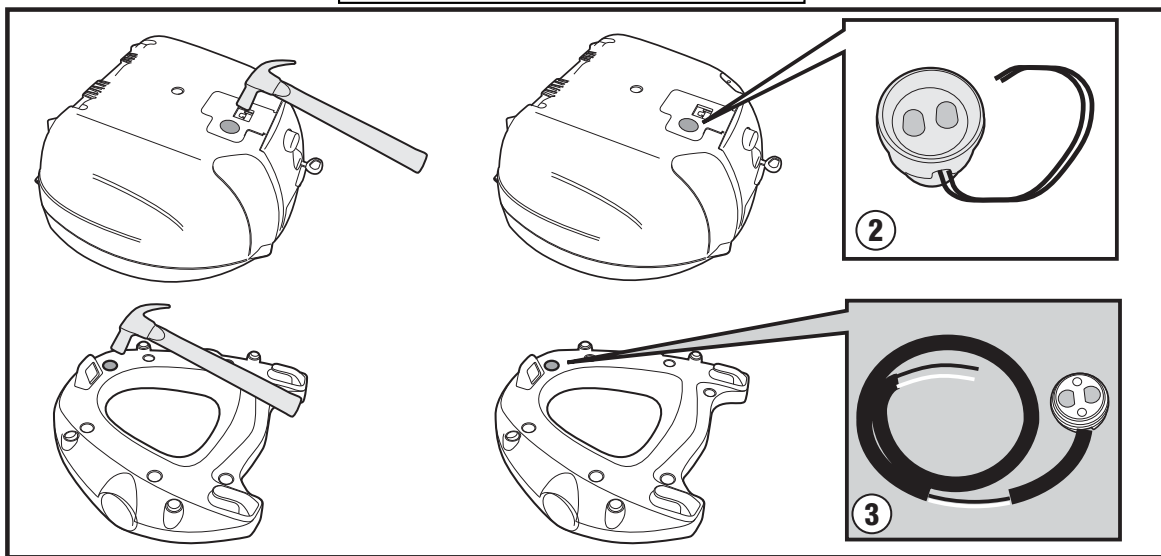

### ATTENZIONE:

Far combaciare le polarità tra piastra - fondo e coperchio

### WARNING:

Match the polarity between the plate - bottom and cover

### AVERTISSEMENT:

Correspondre la polarité entre la plaque - fond et le couvercle

### ACHTUNG:

Spiel der Polarität zwischen der Platte - Boden und Deckel

### ADVERTENCIA:

La polaridad entre la placa - parte inferior y la cubierta

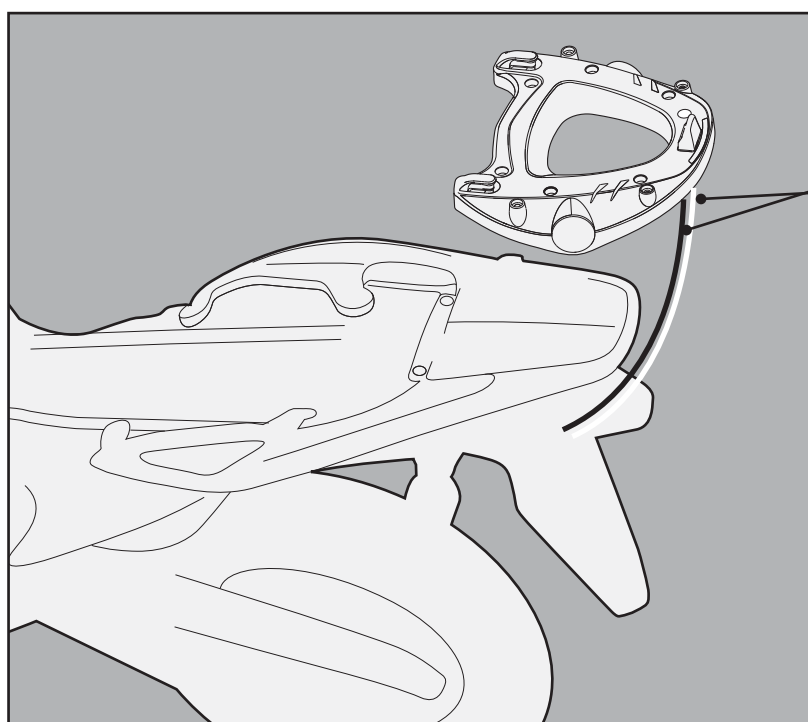

Cavo lampade stop del bauletto  
Top Case stop lamp wire  
Fil du Feu du Top Case  
Kabel vom stoplicht des Koffers  
Cable de la luz de stop del baul

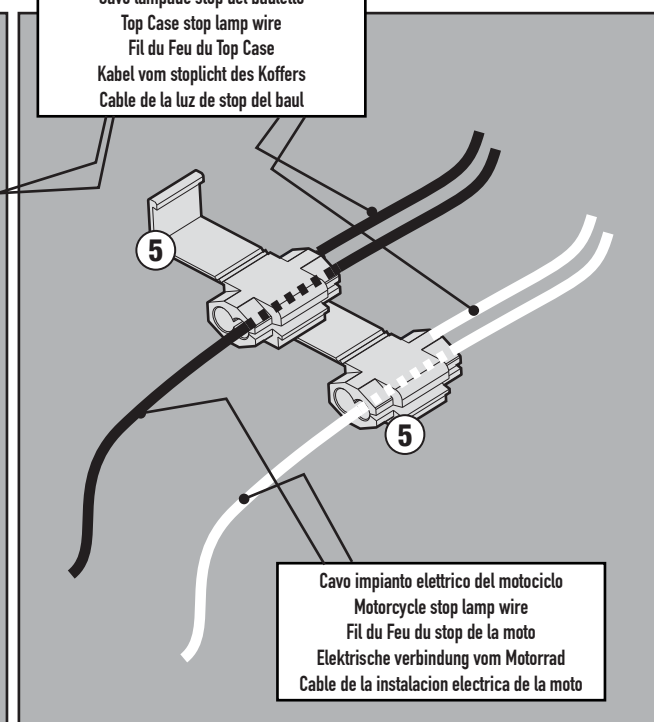

Cavo impianto elettrico del motociclo  
Motorcycle stop lamp wire  
Fil du Feu du stop de la moto  
Elektrische verbindung vom Motorrad  
Cable de la instalacion electrica de la moto