

A3119A - A3119AK

ATTACCHI SPECIFICI PER - SPECIFIC FITTING KIT FOR - KIT DE MONTAGE SPECIFIQUE POUR
SPEZIFISCHER MONTAGEKIT FÜR - ANCLAJE ESPECÍFICO PARA - ANCORADOURO ESPECÍFICO

SUZUKI GSX S1000 (2021)

N°	Descrizione-Description	Caratteristiche-Features	Codice-Code	Quantità-Quantity
1	Supporto - Support - Support Halterung - Soporte - Apoio	-	A3119ADXV A3119ASXV	2 (Right; Left)
2	Vite - Screw Vis - Schraube Tornillo - Parafuso	TBEI M5x30	530TBEI	2
3	Vite - Screw Vis - Schraube Tornillo - Parafuso	TBEI M5x25	525TBEI	2
4	Vite - Screw Vis - Schraube Tornillo - Parafuso	TBEIFN M6x14	614TBEIFN	4
5	Rondella - Washer Rondelle - Scheibe Arandela - Arruela	Foro 5mm / Esterno 15mm	515RON	4
6	Rondella spaccata - Split washer Scheibe - Rondelle fendue Arandela seccionada - Arruela Dentada	Foro 5mm	Z1049	4
7	Rondella In Nylon - Nylon Washer Rondelle Original En Nylon - Nylonscheibe Arandela De Nylon - Arruela De Nylon	Foro 6mm / Esterno 13mm / Sp. 0,5mm	Z1979	4
8	Rondella in gomma - Rubber washer Rondelle en gomme - Gummisheibe Arandela de goma	Foro 6mm / Esterno 16mm / Sp. 2mm	ORONG	4
9	Distanziale - Spacer Entretoise - Distanzstueck Distanciador - Espaçador	Ø16x6 Foro 6,5mm	C16L6F6,5T	2
10	Distanziale - Spacer Entretoise - Distanzstueck Distanciador - Espaçador	Ø16x3 Foro 6,5mm	C16L3F6,5T	2
11	Distanziale - Spacer Entretoise - Distanzstueck Distanciador - Espaçador	Ø8x6 Foro 5,5mm	C8L6F5,5T	4
12	Dado - Bolt - Ecrou Mutter - Tuerca - Porca	Dado Autobloccante Flangiato Ribassato M6 (H.7mm)	6DADIABFN	4
13	Tappo - Cap Fiche - Stecker Enchufe - Boné	-	10COP	4
14	Componenti Originali - Original Parts Parties Originales - Original Bauteile Componentes Originales - Componentes Originais	-	-	-
15	Schermo Specifico - Specific Screen Écran Spécifique - Spezifischen Bildschirm Pantalla Específica - Tela Especifica	-	3119A	-

A3119A - A3119AK

ATTACCHI SPECIFICI PER - SPECIFIC FITTING KIT FOR - KIT DE MONTAGE SPECIFIQUE POUR
 SPEZIFISCHER MONTAGEKIT FÜR - ANCLAJE ESPECÍFICO PARA - ANCORADOURO ESPECÍFICO

SUZUKI GSX S1000 (2021)

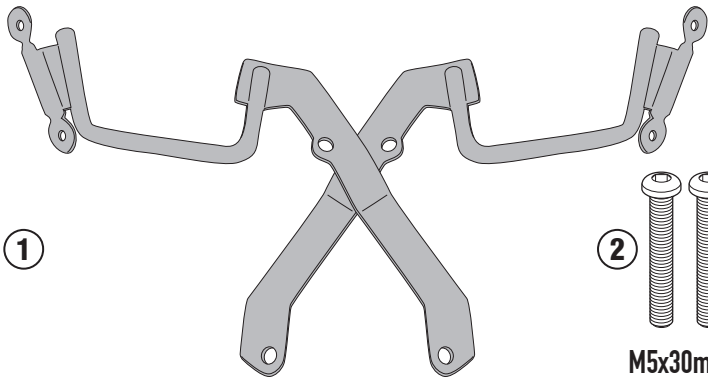

1

A3119ADXV / A3119ASXV

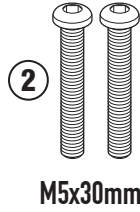

2

M5x30mm

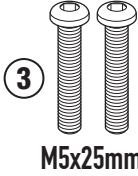

3

M5x25mm

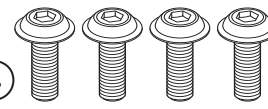

4

M6x14mm



5

Hole Ø5mm/
External Ø15mm



6

Hole Ø5mm

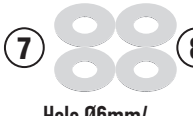

7

Hole Ø6mm/
External Ø13mm/
D.0.5mm



8

Hole Ø6mm/
External Ø16mm/
D.2mm

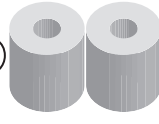

9

Hole Ø6.5mm/
External Ø16mm/
H.6mm



10

Hole Ø6.5mm/
External Ø16mm/
H.3mm

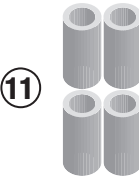

11

Hole Ø5.5mm/
External Ø8mm/
H.6mm

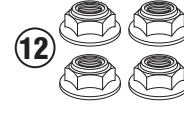

12

M6

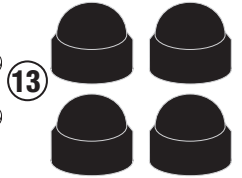

13

10COP

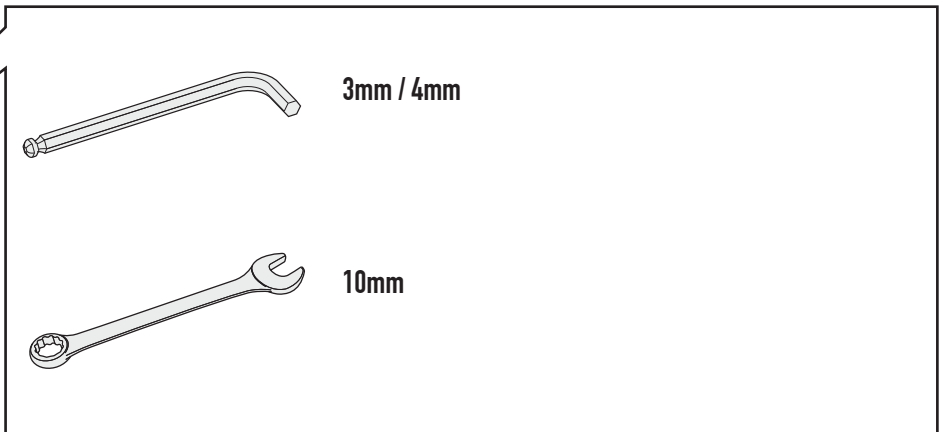
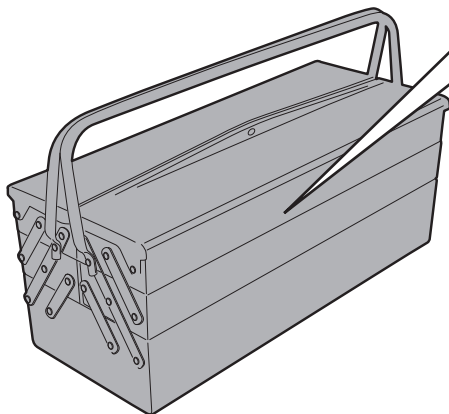

3mm / 4mm

10mm



CHECK THE SCREW LENGTH HERE

ISTRUZIONI DI MONTAGGIO - MOUNTING INSTRUCTIONS
 INSTRUCCIONES DE MONTAJE - BAUANLEITUNG
 INSTRUÇÕES DE MONTAGEM

A3119A - A3119AK

ATTACCHI SPECIFICI PER - SPECIFIC FITTING KIT FOR - KIT DE MONTAGE SPECIFIQUE POUR
SPEZIFISCHER MONTAGEKIT FÜR - ANCLAJE ESPECÍFICO PARA - ANCORADOURO ESPECÍFICO

SUZUKI GSX S1000 (2021)

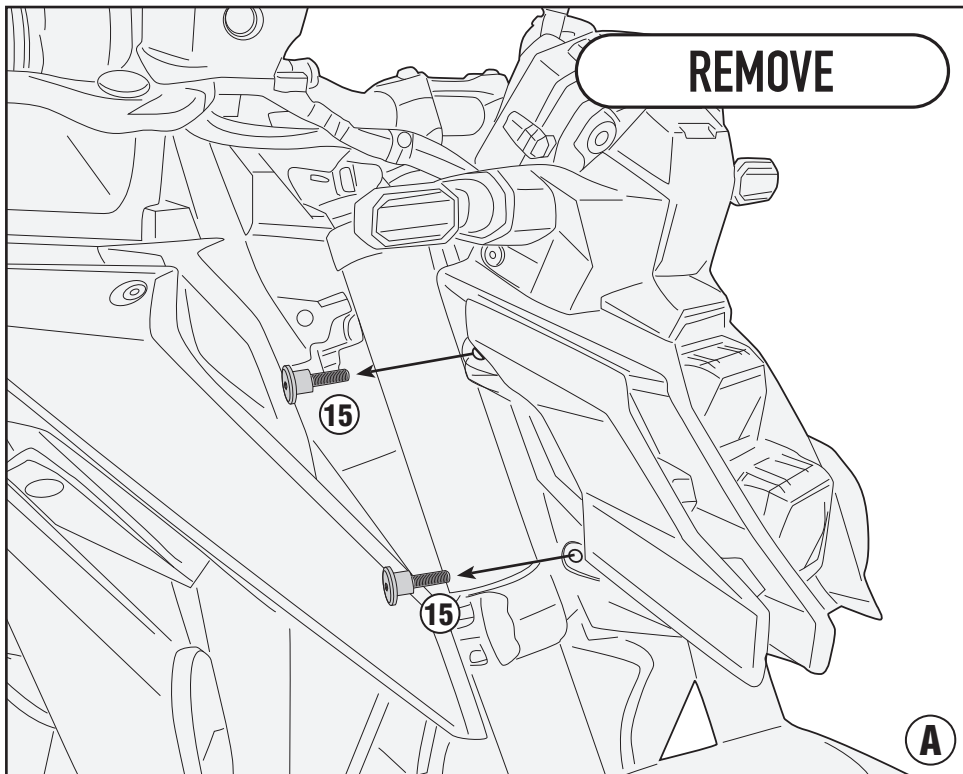
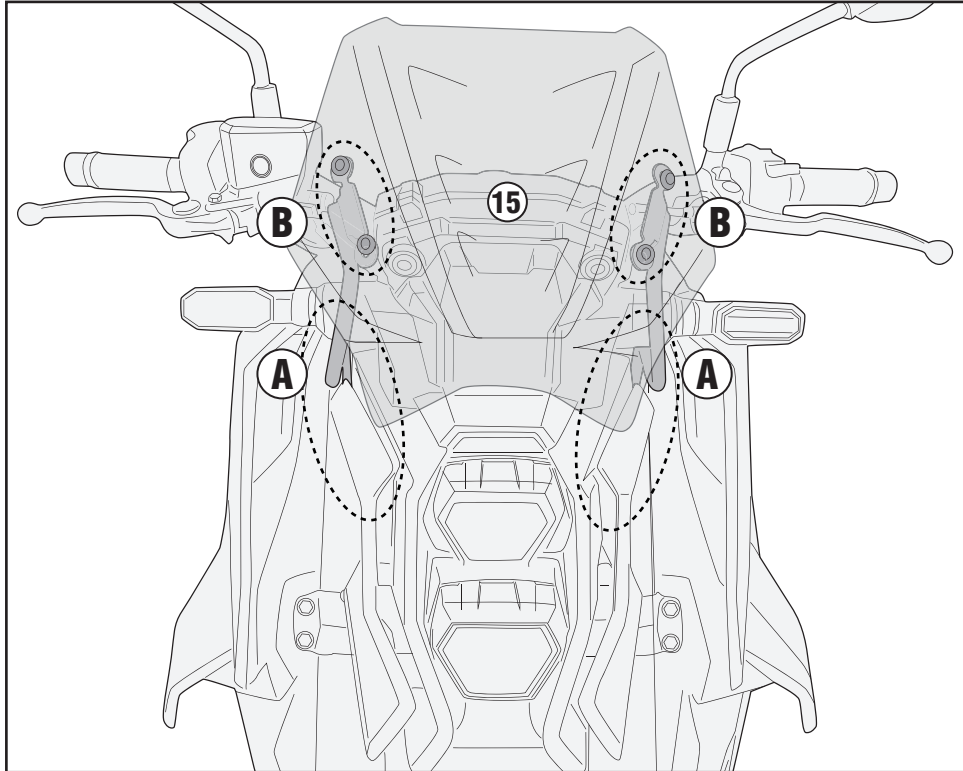

A3119A - A3119AK

ATTACCHI SPECIFICI PER - SPECIFIC FITTING KIT FOR - KIT DE MONTAGE SPECIFIQUE POUR
SPEZIFISCHER MONTAGEKIT FÜR - ANCLAJE ESPECÍFICO PARA - ANCORADOURO ESPECÍFICO

SUZUKI GSX S1000 (2021)

