

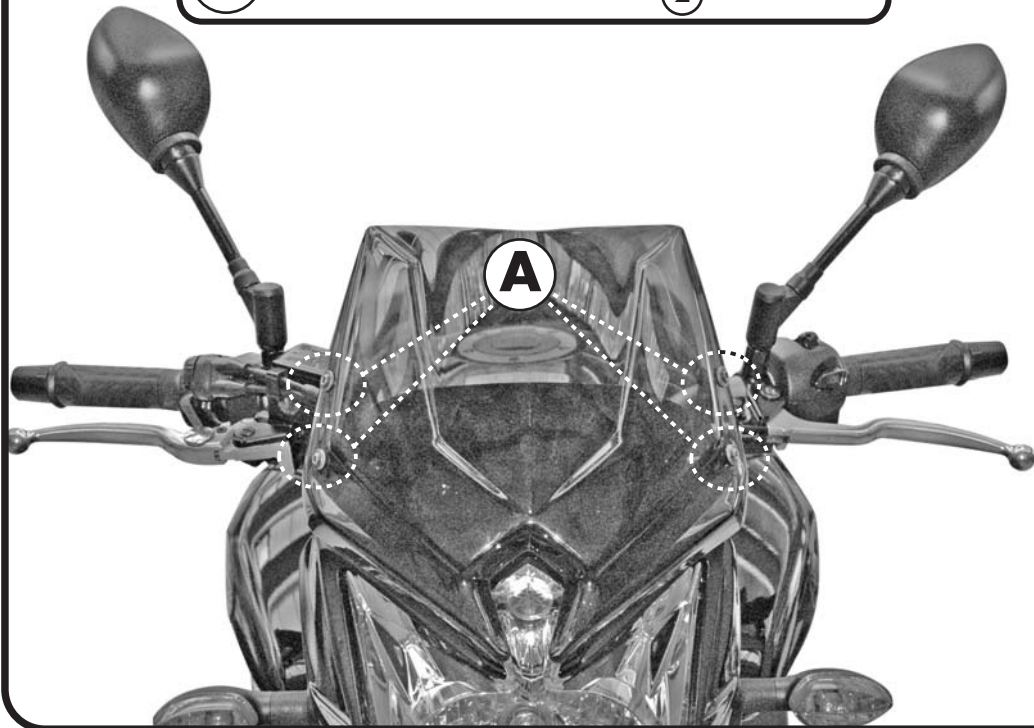

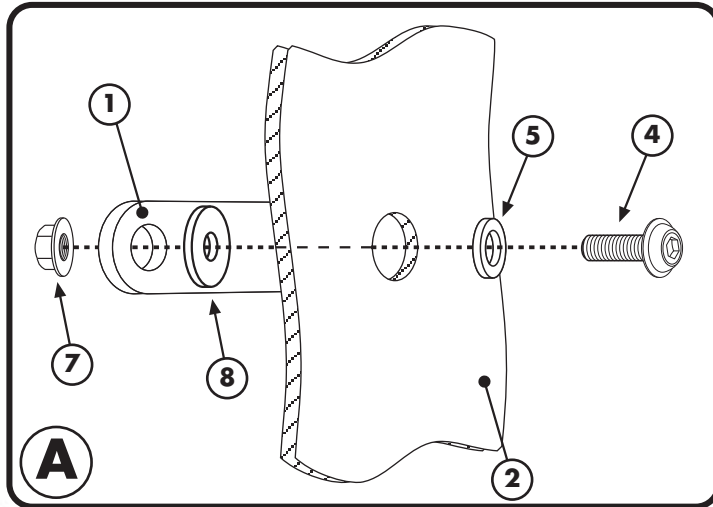





# YAMAHA FZ8 2010

ISTRUZIONI DI MONTAGGIO - MOUNTING INSTRUCTIONS  
 INSTRUCTIONS DE MONTAGE - BAUANLEITUNG - INSTRUCCIONES DE MONTAJE



<p>①</p>  <p><b>SUPPORTO</b> SUPPORT SUPPORT HALTERUNG SOPORTE</p> <p><b>Q.TY n.2(Dx-Sx)</b></p>	<p>②</p>  <p><b>Q.TY n.1</b></p>	<p>③</p>  <p><b>VITE TEF M6x30mm</b> SCREW SUPPORT VIS SCHRAUBE TORNILLO</p> <p><b>Q.TY n.2</b></p>	<p>④</p>  <p><b>VITE TBEIFN M6x16</b> SCREW VIS SCHRAUBE TORNILLO</p> <p><b>Q.TY n.4</b></p>	<p>⑤</p>  <p><b>RONDELLA TEFLON Z1979</b> WASHER Ø6mm RONDELLE Ø6mm SCHEIBE Ø6mm ARANDELA Ø6mm</p> <p><b>Q.TY n.4</b></p>
<p>⑥</p>  <p><b>DISTANZIALE Ø20x10mm</b> Foro Ø8,5mm, V447 SPACER ENTRETOISE DISTANZSTUECK DISTANCIADOR</p> <p><b>Q.TY n.2</b></p>	<p>⑦</p>  <p><b>DADO A.B. M6</b> FLANGIATO BOLT M6 ECROU M6 MUTTER M6 TUERCA M6</p> <p><b>Q.TY n.4</b></p>	<p>⑧</p>  <p><b>RONDELLA IN GOMMA</b> ORONG RUBBER WASHER RONDELLE EN CAOUTCHOUC GUMMI SCHEIBE ARANDELA DE GOMA</p> <p><b>Q.TY n.4</b></p>		

